



INDUSTRIAL
3D ANIMATIONS & GRAPHIC DESIGN IN
THE FIELD OF **ENERGY** ESPECIALLY FOR
OFFSHORE , MARINE & RENEWABLES

2024 New Edition



INTERNATIONAL
ENERGY CLUB

WWW.INTERNATIONALENERGYCLUB.COM

We Create Your Imagination ...

Get to know us, it's worth it

We Are International Energy Club

International Energy Club is a dedicated 3D animation studio, video, and graphic design company, comprising researchers, experts, and artists, animators, and programmers who look at the developments of energy industries from a new perspective. Having commenced organized professional activities with more than 13 years' experience, this club has managed to carry out many international projects, all of them in the fields of Offshore oil & gas, Marine, and Renewable energies. We're perfectionists, Idealists, and Creators. We do work, we're proud of; Work that makes an impact on our clients' business. We do it by bringing bright people together from all walks of life and every imaginable background, letting them loose on a challenge, and giving them the freedom to explore the possibilities. We are problem-solvers, solution-finders, and askers of "what if?" We help you tell your story in the most authentic way possible and deliver it in a strong, beautiful, thoughtfully crafted manner. When you trust International Energy Club with your project, you can count on the same proven, time-tested approach that has made hundreds of previous projects successful. So let's get started. Meet our team, see our works, and read about a few reasons, why you should consider cooperation with International Energy Club.

Mohammad Sadegh Amiri

Founder & Projects Manager



What Makes Us Different?

▶ When you sit with us for the first time, you'll find that your project is already halfway complete. You won't have to waste precious time explaining the fundamentals or even some of the more complex subject matters. We get it. In fact, we are more than just experienced animators or designers. We're your partners! As a strategic, branding, and marketing group in Offshore, Marine & Renewable energies, we have the right team to service your needs. Or, if you're unsure of your exact needs, we can help you with that too! We ask the right questions to get to the heart of your challenges and then work with you to design meaningful solutions. We are purposeful in selecting organizations to work with because we don't just want clients. We want partners. Similarly, you should be purposeful in selecting a group that understands your mission and its goals. When you work with International Energy Club, you get a passionate team working to make your projects and your organization successful. We would love the opportunity to show you what we're made of and what we can make of your project. At International Energy Club it is all about you and your business in the energy industry. We pride ourselves on building strong, solid, and long-lasting relationships with the people in the industry that we deal with. With free advice and excellent communication throughout your project, the International Energy Club team, handles all your design, printing, web, industrial animations, documentary, news, and social media needs. From the initial steps, our team manages the entire process so that you are free to spend your time building your business.

Why International Energy Club ?

International Energy Club's management staff is fully determined to turn this group into a creative-ideas think tank for the International energy companies in all four of its main activities. In an aim to achieve this goal, International Energy Club as an utterly private and independent body has done its best to create many distinctions on its own, without receiving any moral and material supports. Our most important points of distinction, which have been institutionalized in us and contain no advertising slogans, are as below:

- We think and work in a group.
- We would work with international standards.
- We have answers to all your questions.
- We fight for new ideas in the field of energy.
- None of our employers are dissatisfied with our services.
- Working in the field of energy is our biggest mission.
- We train all of our staff to work in the field of energy.
- We enjoy a creative, experienced and motivated, management staff.
- We perform no energy project without enough research
- We enjoy a professional and comprehensive archive and an advanced database
- We are always analysing all the international projects in the field of our activities
- We share our experiences with your company, not trying to gain an experience.
- We accept new projects based on our capacities.

- We give our employers the right to choose in all circumstances and make the best decisions.
- We think well, decide properly. We accomplish very quickly and work precisely.
- When we accept to carry out your project, we take responsibility for the entire project on your behalf.
- **We believe that all of our clients are the largest and most important companies in the world.**
- We work based on the timetable and the delivery time of the project is exactly the same as was fixed at the beginning of the project.
- Before we start a project, we make sure we have fully understood your demands.
- International Energy Club never has performed and will not carry out a project which is irrelevant to the energy industry.
- We not only fully supervise our own activities, but also keep our eyes on the activities of our contractors until the delivery time of the project.
- We think about all the details of the project and in no circumstances we fail to meet your demands.
- We enjoy a coherent, young, creative, capable, determined, and very motivated staff to provide the best services to your company.
- International Energy Club has fully capable to render services in its four main fields of activities, which only are in its monopoly.
- In collaboration with International Energy Club, you would accomplish your desires very easily, with high quality and reasonable price.

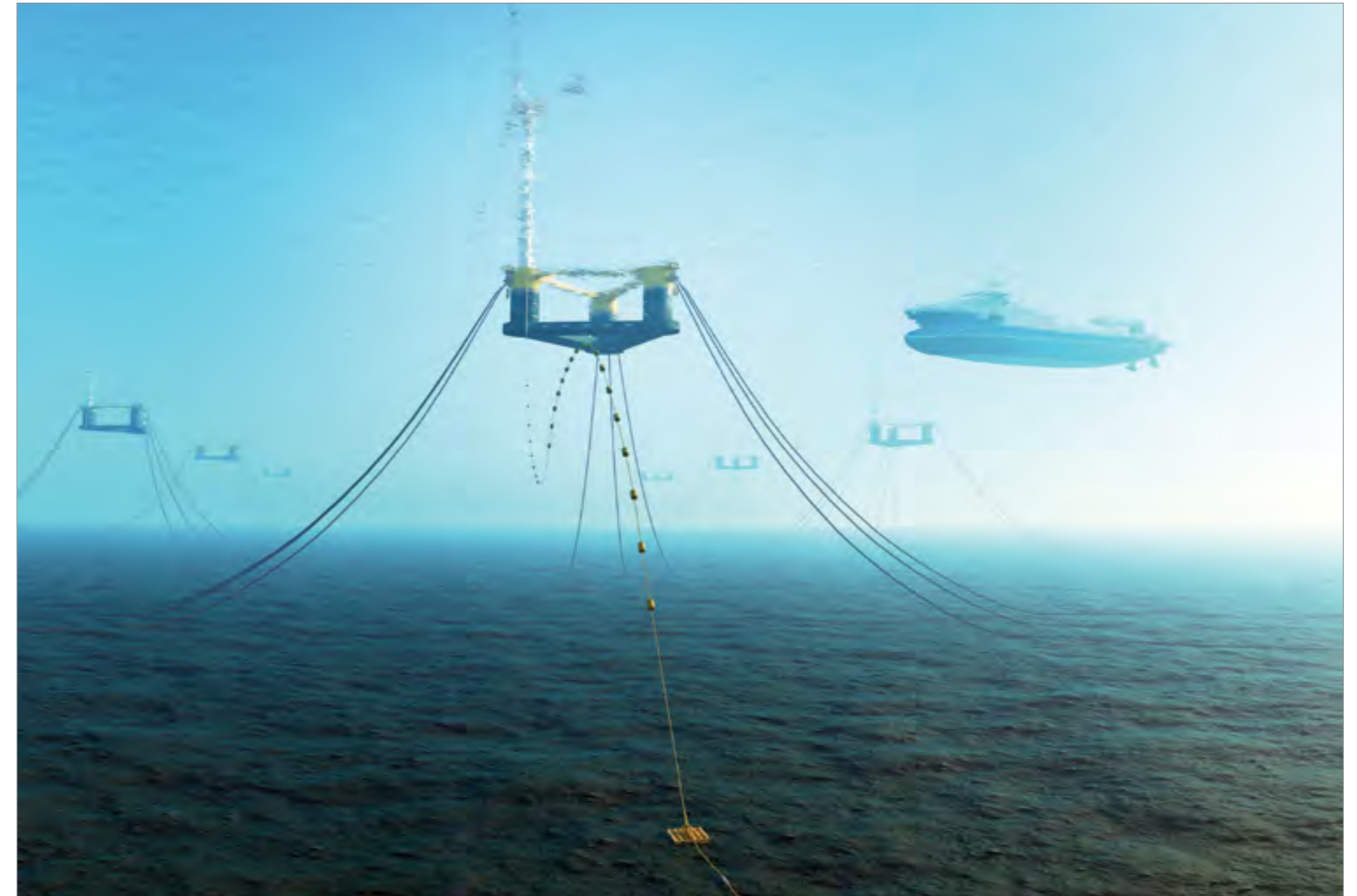



We Are Among TOP 2 Industrial Animation Studios In The World

With having a record of 13 hours high quality 3D video production in the field of offshore, marine and renewable energies for many well-known clients in the world, International Energy Club is among top 2 industrial animation studios in the world. Naturally, we believe our vast experience and world-class creative make us industry leaders, but we'd rather take your word for it! We have a team of highly skilled & creative stuffs, working endlessly with an aspiration to change the face of global offshore oil and gas, marine and renewable energy with use of 3D animation and other media features. That is why many offshore & marine experts in the world talk about International Energy Club and introduce us to others. By taking a closer look at the continuation of our portfolio in this catalog, you can well understand the global reputation and quality of our work.

We Have The Best 3D Database For Offshore, Marine & Subsea Industries

Over the past 13 years, International Energy Club has built an extensive database of industry-specific knowledge and visual assets, enabling us to deliver highly detailed and accurate 3D animations tailored to the unique needs of the offshore, marine, and subsea sectors. Our vast experience, accumulated through years of working with industry leaders, ensures that every animation we produce meets the highest standards of quality and precision. Clients can trust that our deep expertise and comprehensive database allow us to consistently create animations that not only meet but exceed their expectations, bringing their projects to life with unmatched clarity and detail.



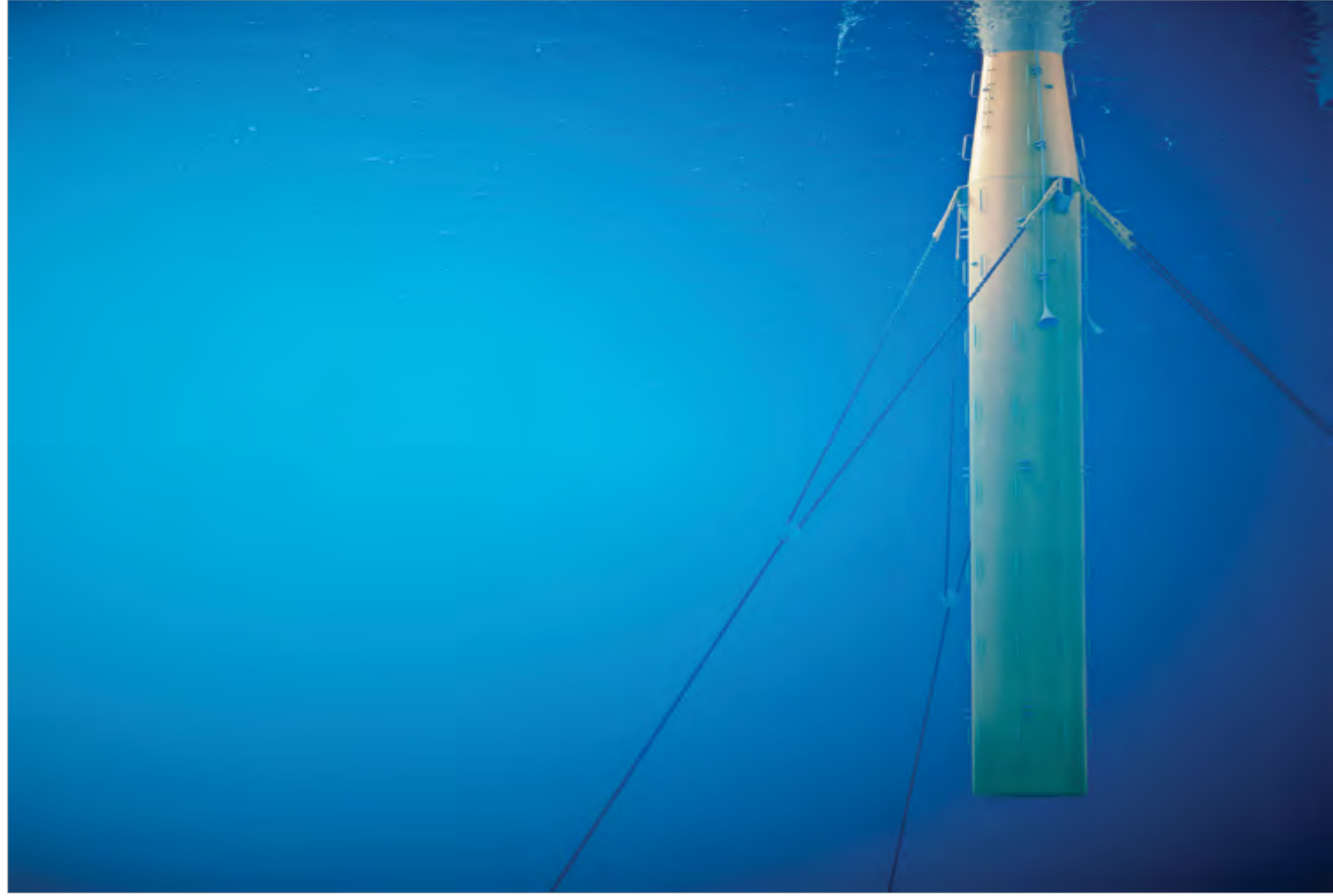

Animation Is A Great Choice For Your Trade Show

Speed is also a crucial component of 3D animation. Not only can you make an object look beautiful—you can explain its benefits faster, reaching a wider audience than you could in real time. 3D animation can be a tool to more efficiently tell your story, and it can also give viewers access to angles they wouldn't typically see, allowing you to sell more features. And because of its better-than-real-life appearance, 3D animation can dazzle from all the way across a room, making it a great choice for trade shows.



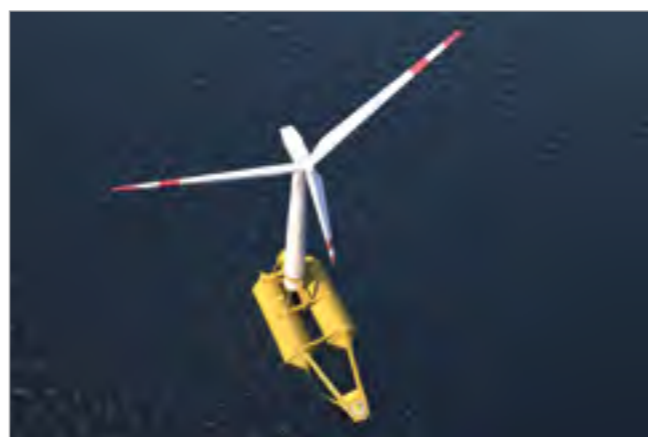



Why You Need To Work With International Energy Club?

At International Energy Club, we are guided by our animation services strong founding principal in the belief of visualizing a better world. Every day we seek to improve ourselves and our company by bringing those 3D animation services visualizations to life. That's why we are passionate about the standards of work we deliver and quality is of critical importance to us. We strive to achieve high standards of customer satisfaction, providing our customers with accurate and expert advice which meet and exceed their expectations. To enable us to do this, we take our position seriously when it comes to ensuring that we fully understand our products and projects. The services we provide go beyond current best practice guidance, and provide uncompromised levels of quality.

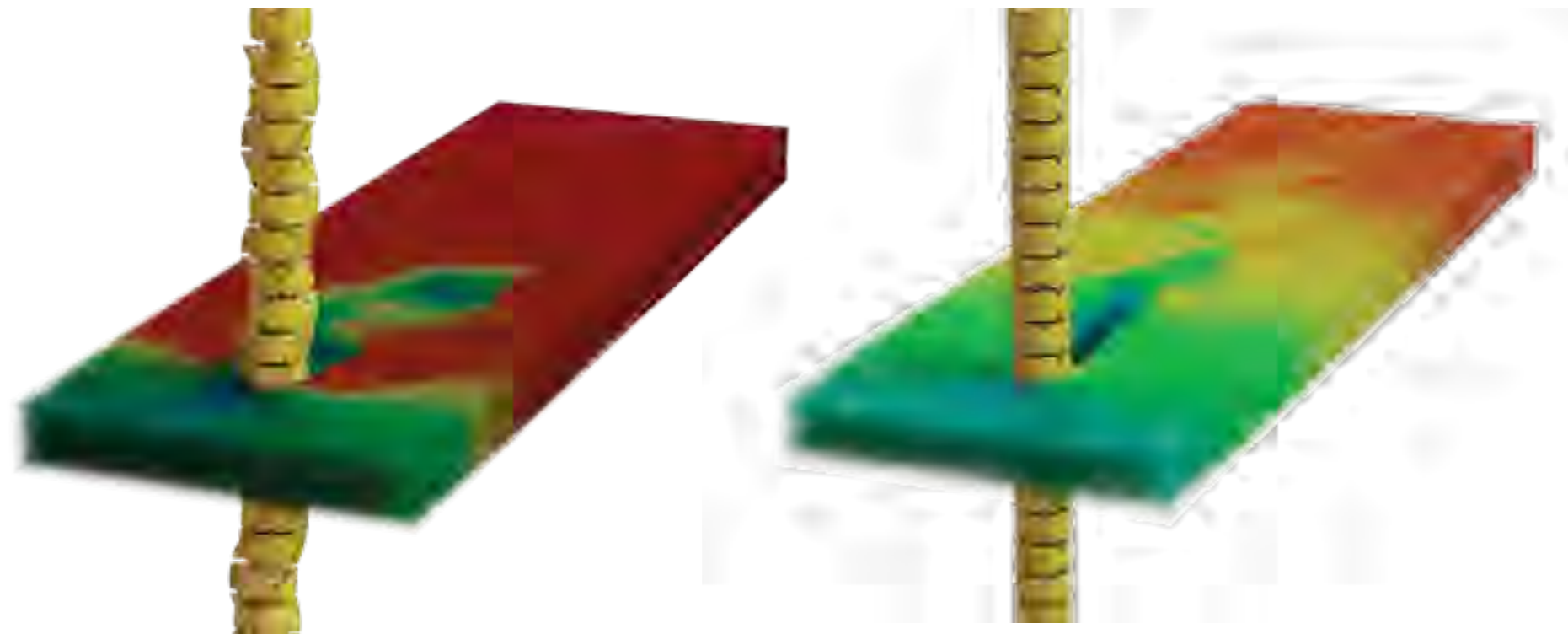



We Turn Concepts into Realities

▶ We do more than serve our markets. We shape them. We turn concepts into realities, blueprints into assets and ideas into 3D animations.







You Win We Win

▶ We value our clients' short and long-term business success above all else. We know we've succeeded when you do. Win-win.



Do You Know **1 Minute Of Video** Is Equal With **1.8 Million Words** To Your Audience?

-Forrester Research

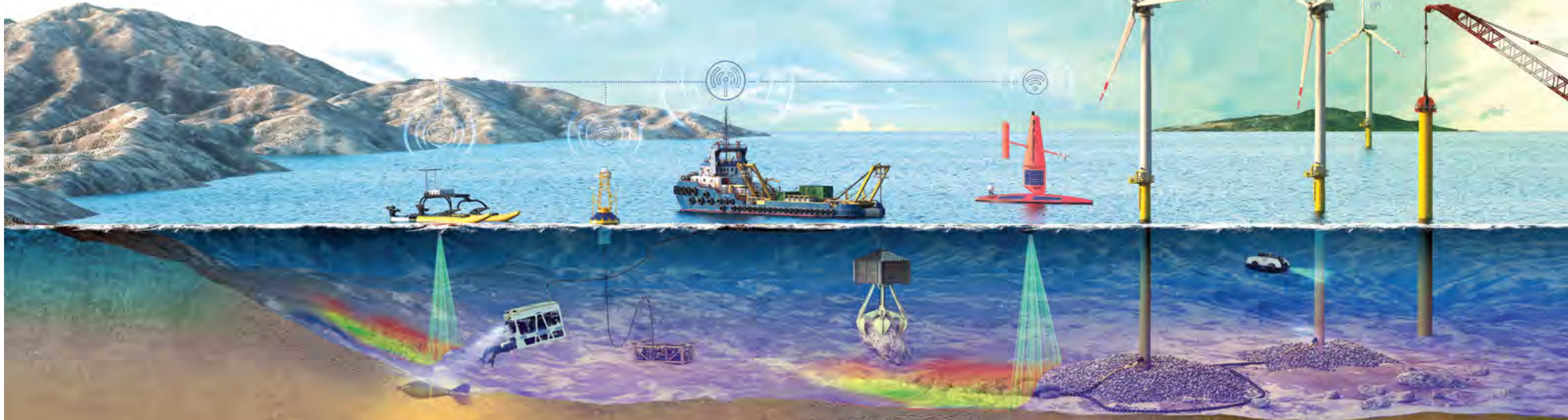





Getting the project done on time is as important as getting it done on budget. You don't want to miss an investor presentation or a new product launch because your animation company missed a deadline. International Energy Club stays on time and budget with constant communication and by giving you realistic and true expectations from the very beginning.

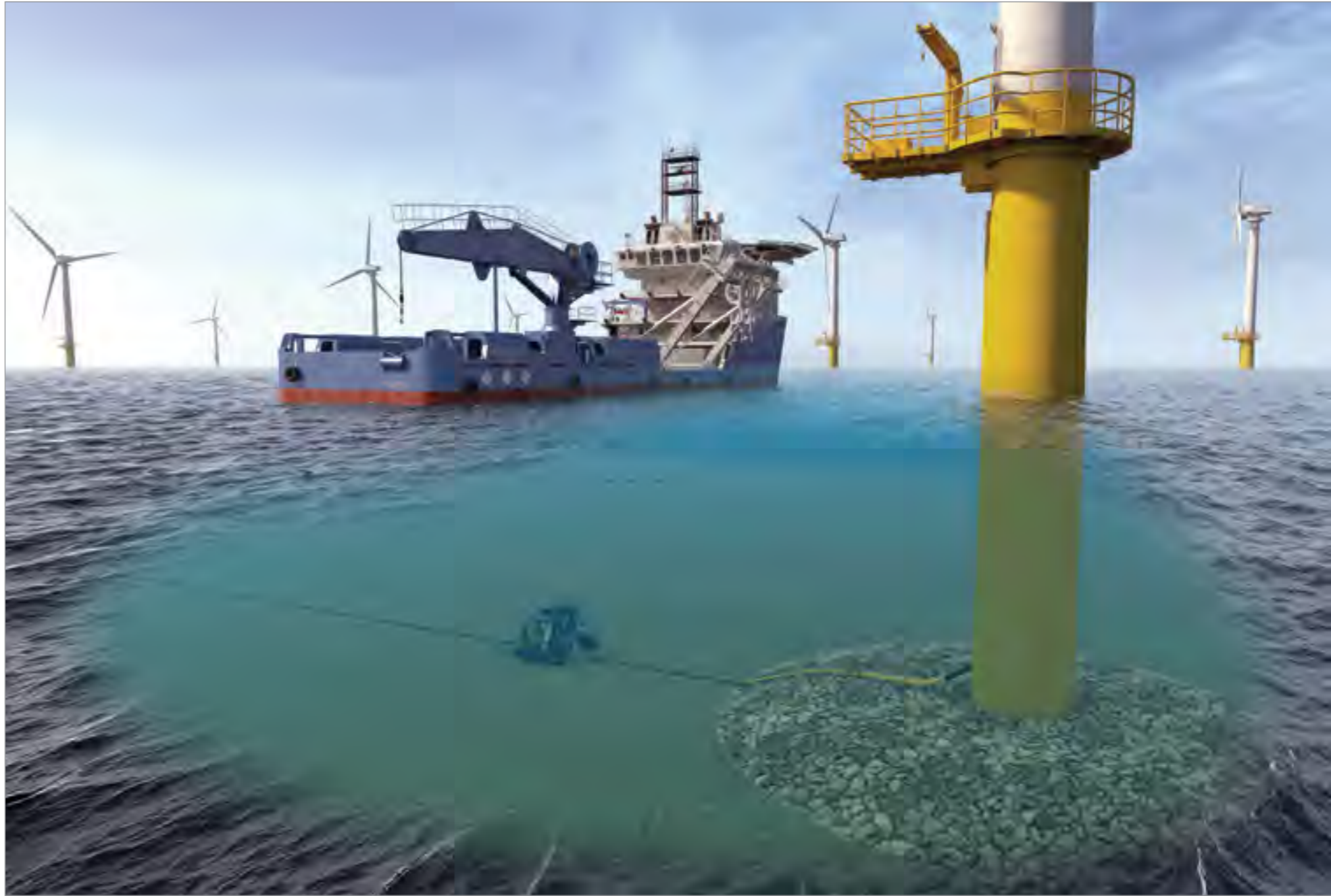



From Concept-To-Completion

Give us your ideas, concepts, and even your napkin sketches and we can produce realistic looking 3D renderings, schematic drawings, and commercial quality animations to showcase your concept. We can drive all of your marketing efforts, visualization and animation needs for your project from concept-to-completion.



It is much safer and more cost effective to train your staff with 3D animation and simulations before going to the actual job site.

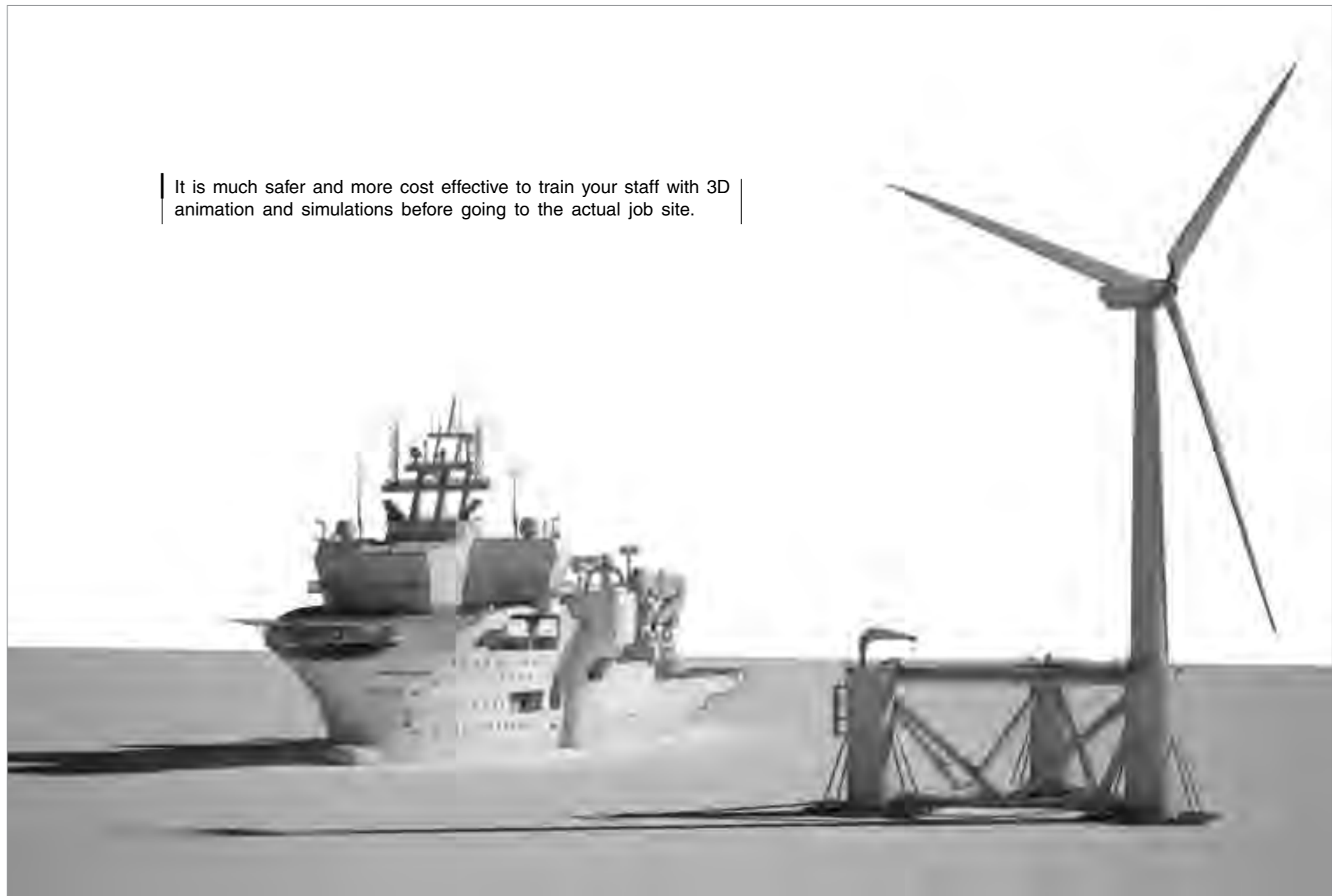







Let's Show Your Clients How Great You Are.

▶ You may be working hard for your business but your business is more than just a building. Its people, products and services, it's how you interact with customers. It's how your company is perceived in the global market.

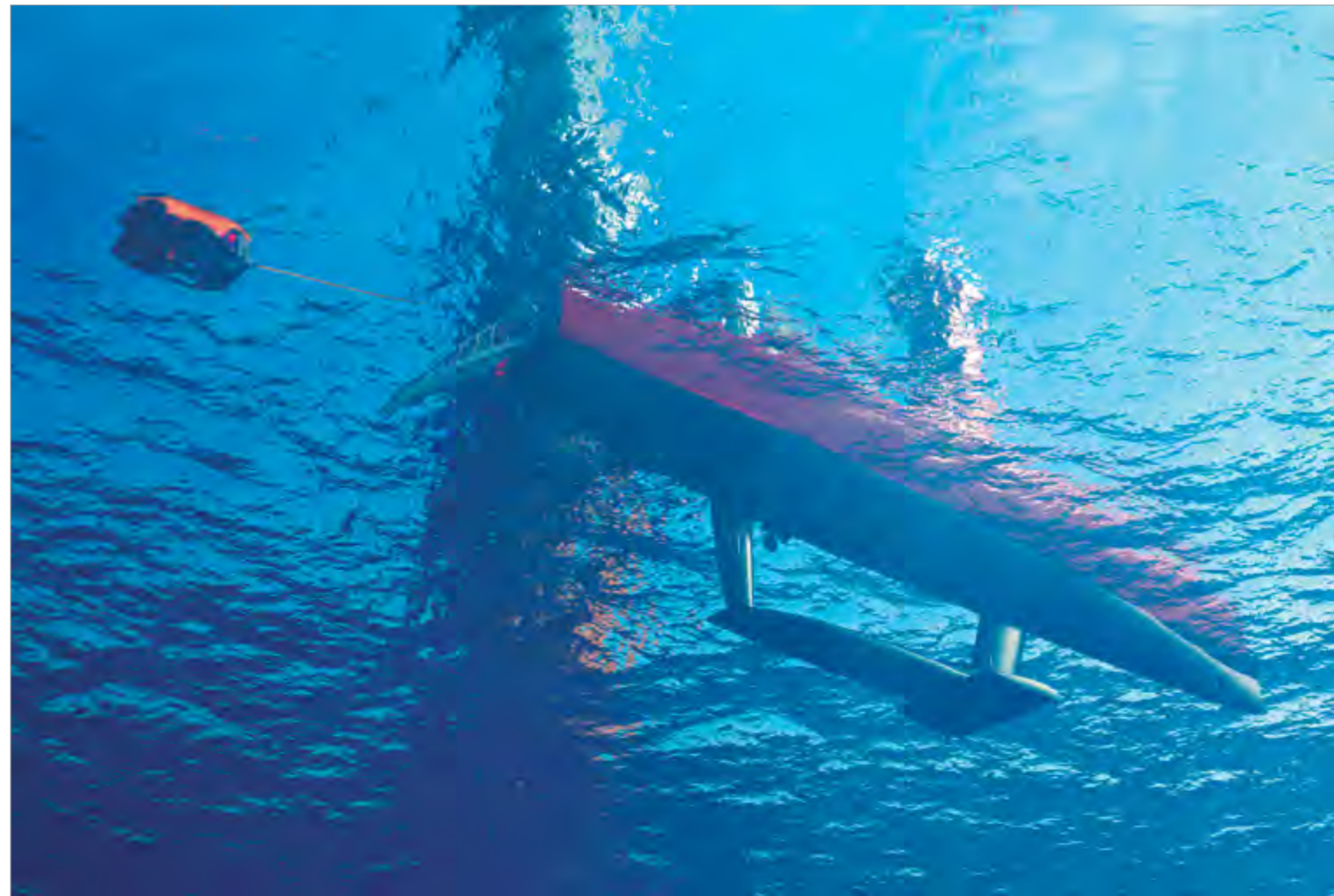

We like New Challenges

We are deeply intertwined within the oil and gas animations – from onshore to offshore, to subsea and beyond. That's why we look at every presentation as a new challenge to get your heart racing; your blood pumping and excited about what's going to happen next. It's that emotion, coupled with your key messaging, that helps drive sales and impacts your bottom line. In fact when you sit with us for the first time, you'll find that your project is already half way complete. We would love the opportunity to show you, what we're made of and what we can make of your project. We admit it. It's true. We're All Up in Your Business.

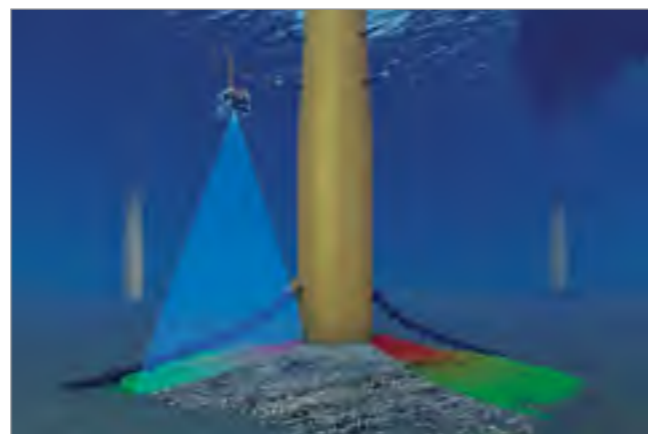
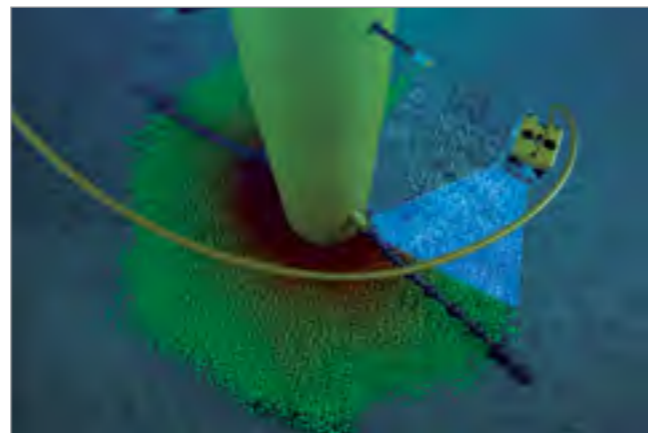
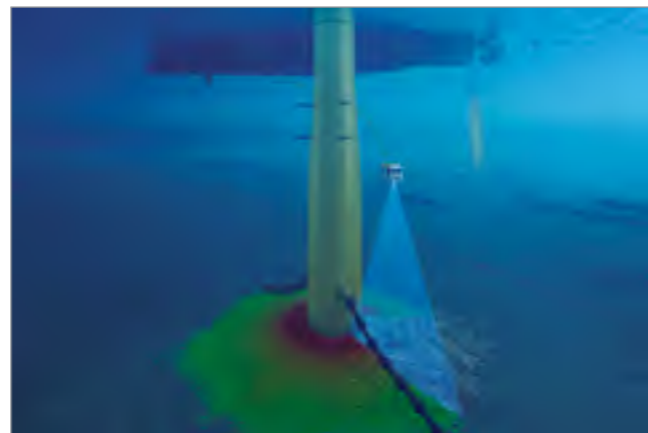

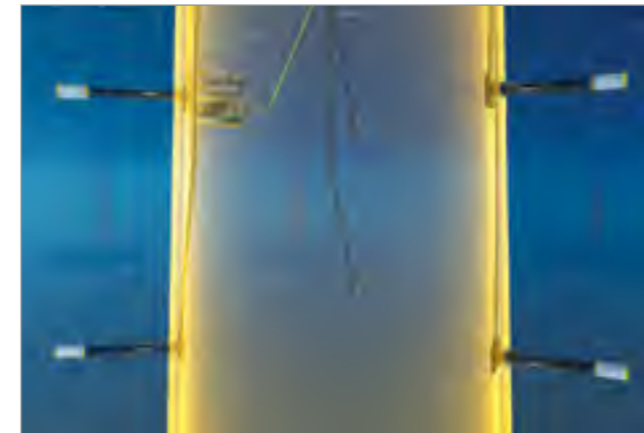

We Have Made A Mark In Everything We Have Created

International Energy Club is one of the fast growing and leading 3D animation studio in the world. With a vast experience in creating 3D animation for many international companies in different countries, our team of 3D artists have gained the expertise in every area of animation possible. At our 3d animation studio, our artists have the technical knowledge to turn your concept into an impressive 3D animation film.

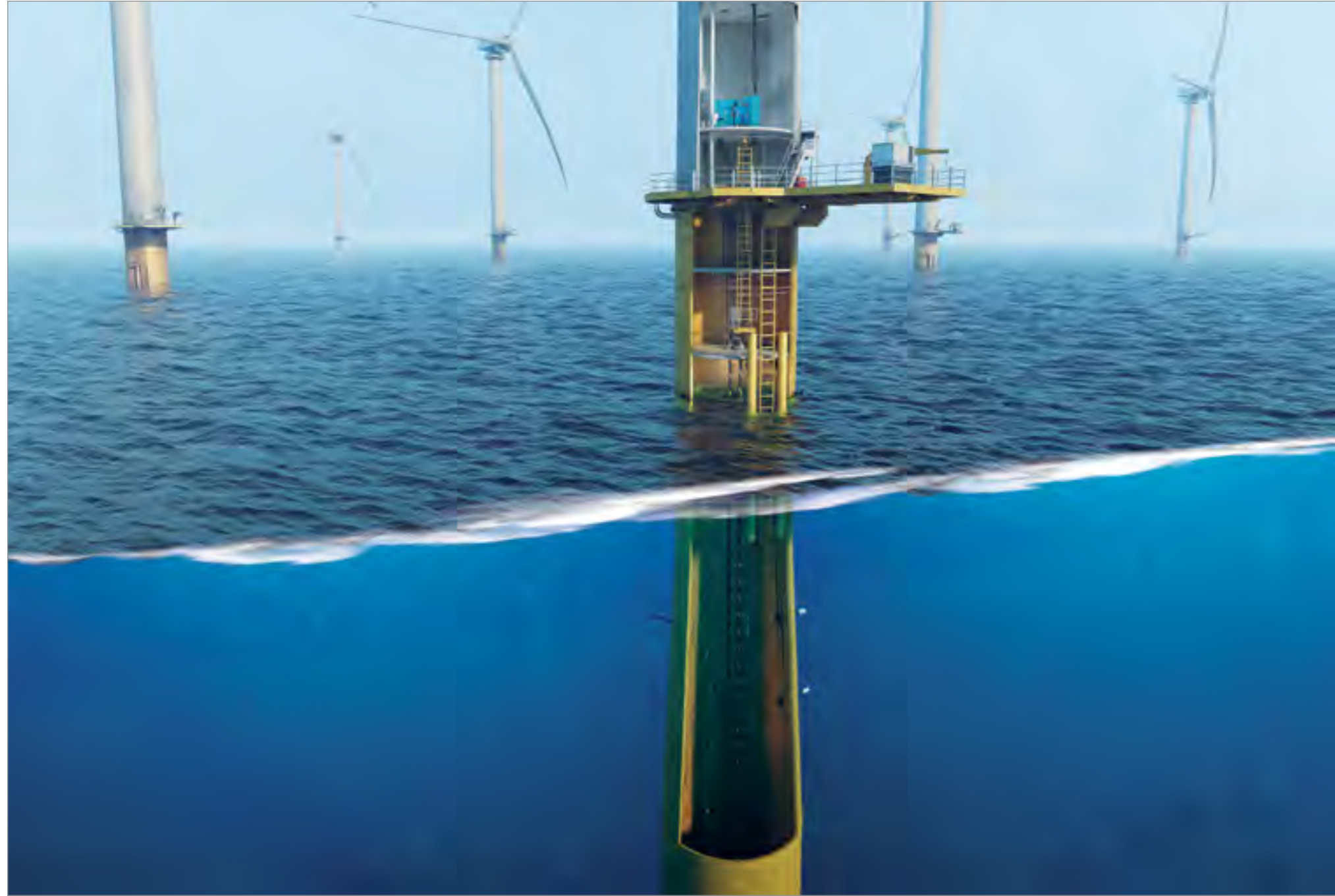

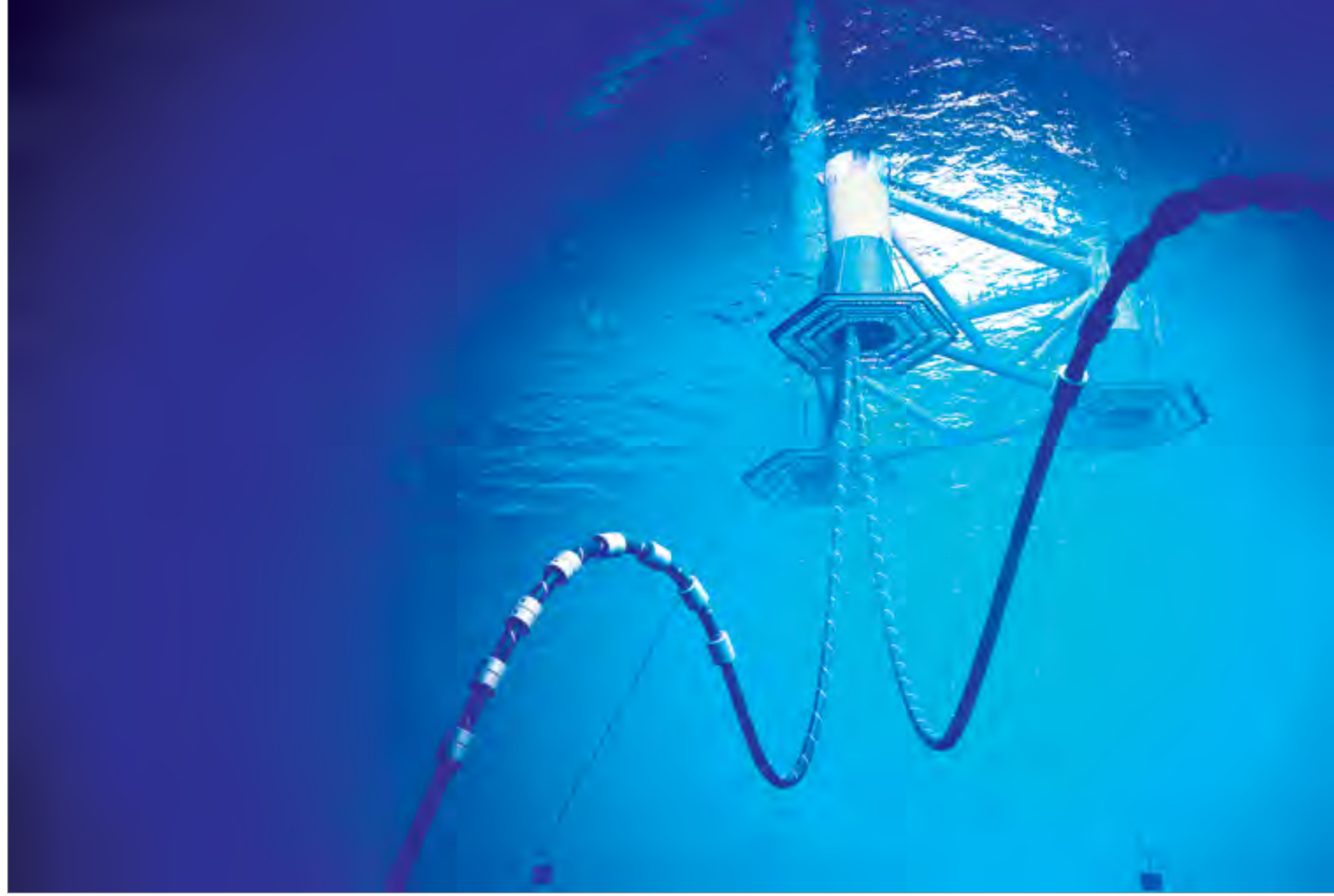



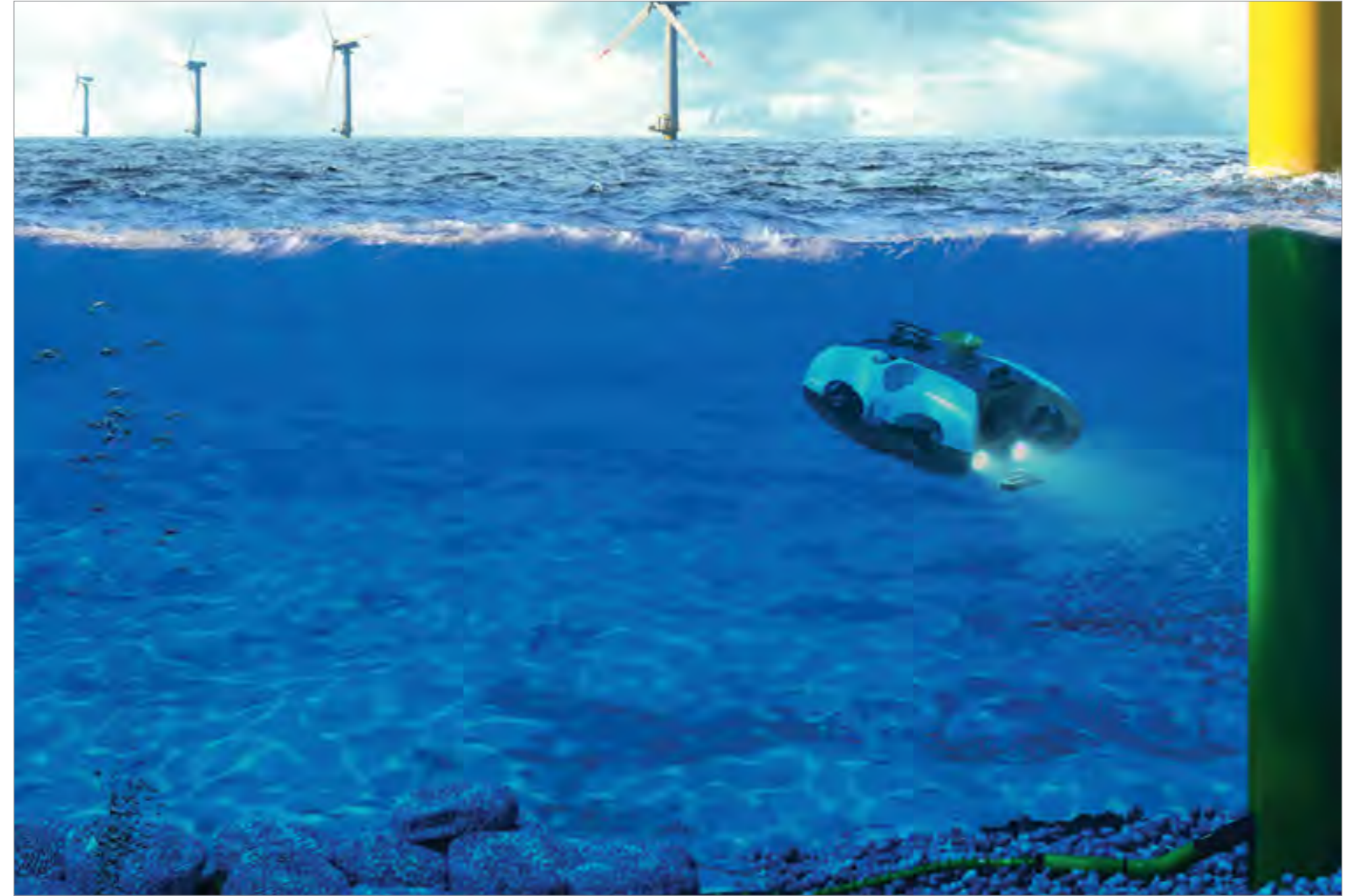
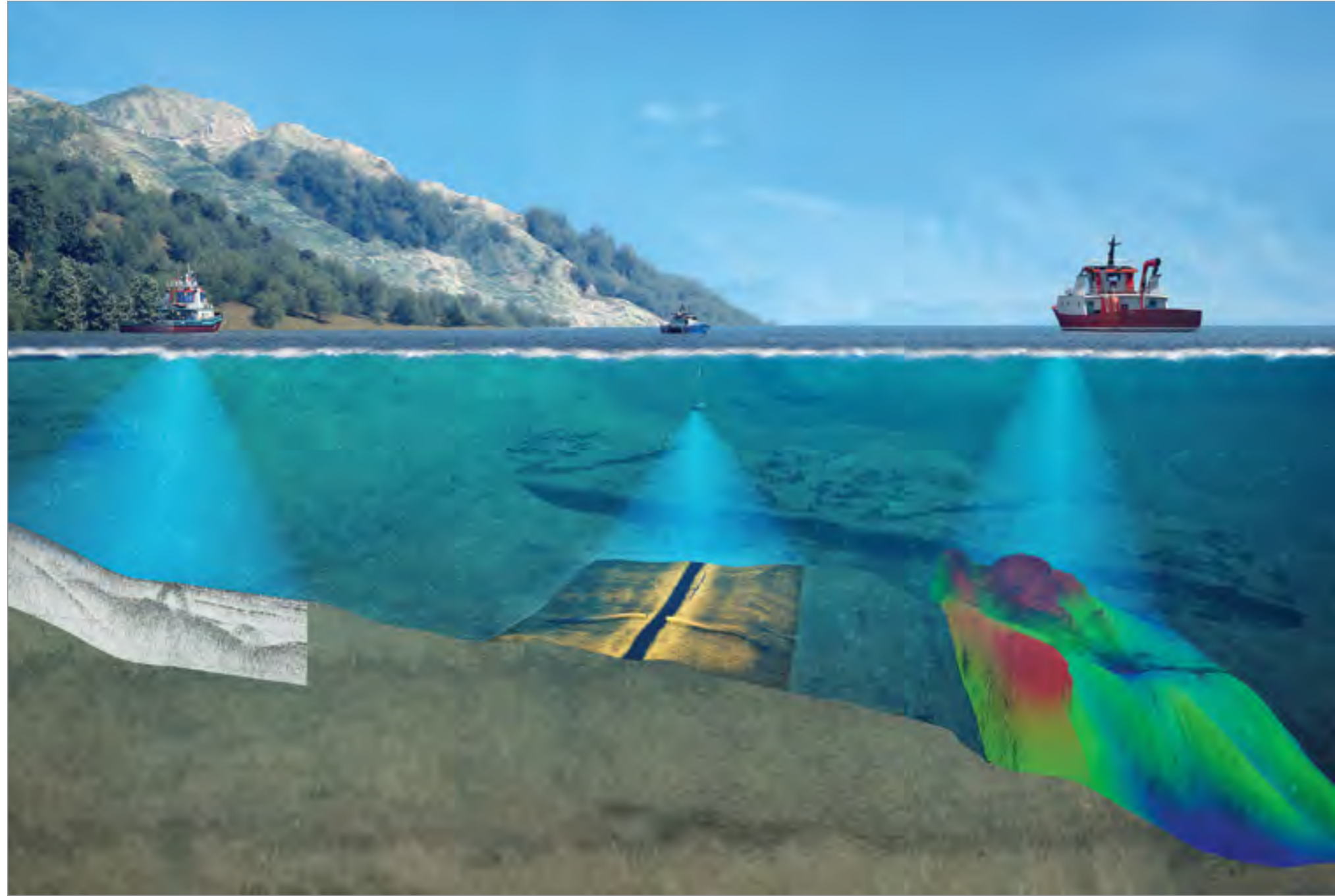



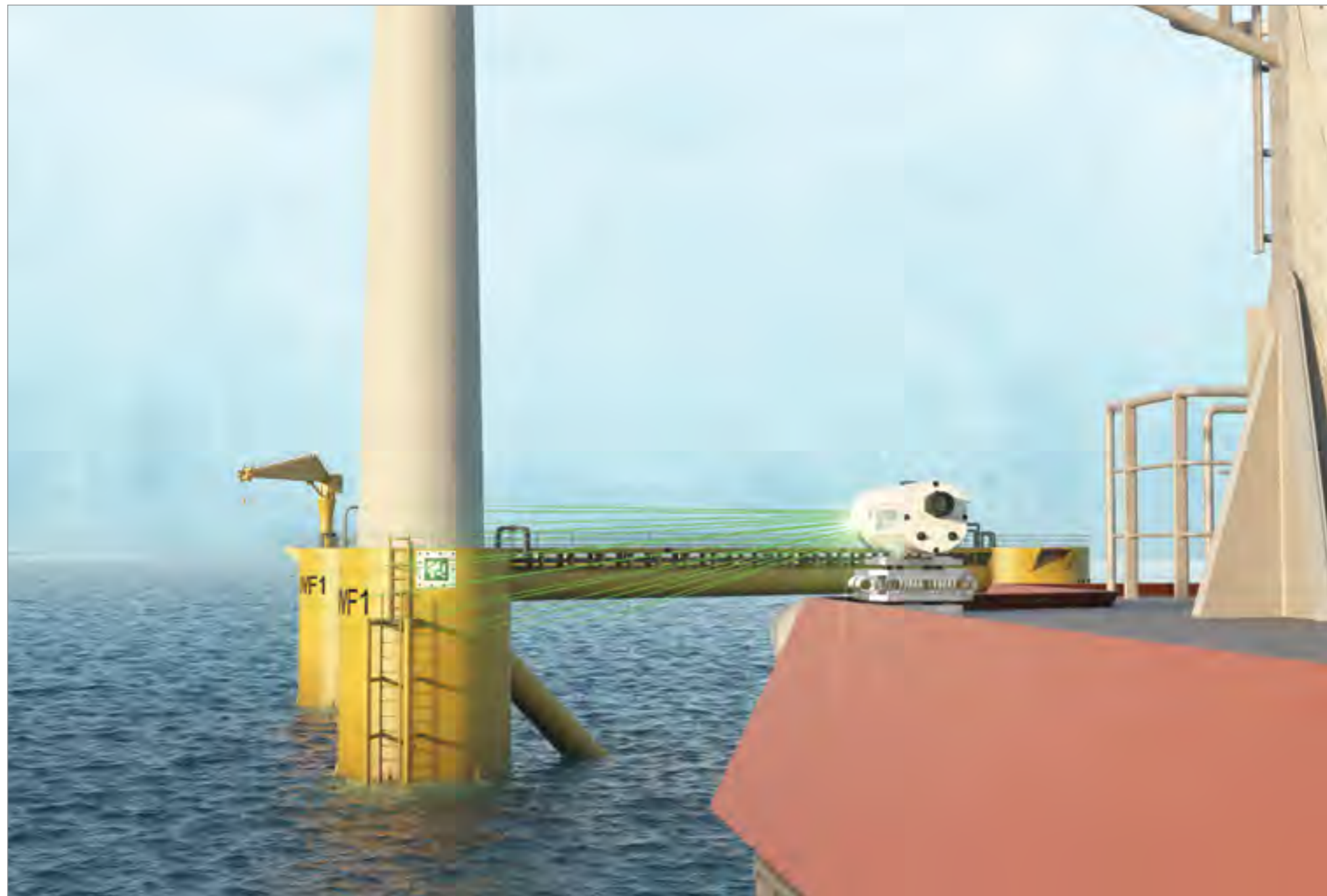

You Have A Higher Chance Of Being Successful

► By using animations, your presentations will convey a much greater understanding about the technical data that you are imparting to your clients. Use our animations not to do away with, but to augment and to simplify the technical data and reports. Use our eye-catching animations and pleasing sounds so you have a higher chance of being successful in your endeavors.







▶ If you have a creative challenge and want to have a world-class team of artists, designers, and technical directors, in a complete VFX studio, then look no further. We are well-known for our world-class services with years of experience and the latest technology to deliver the highest quality product to you.

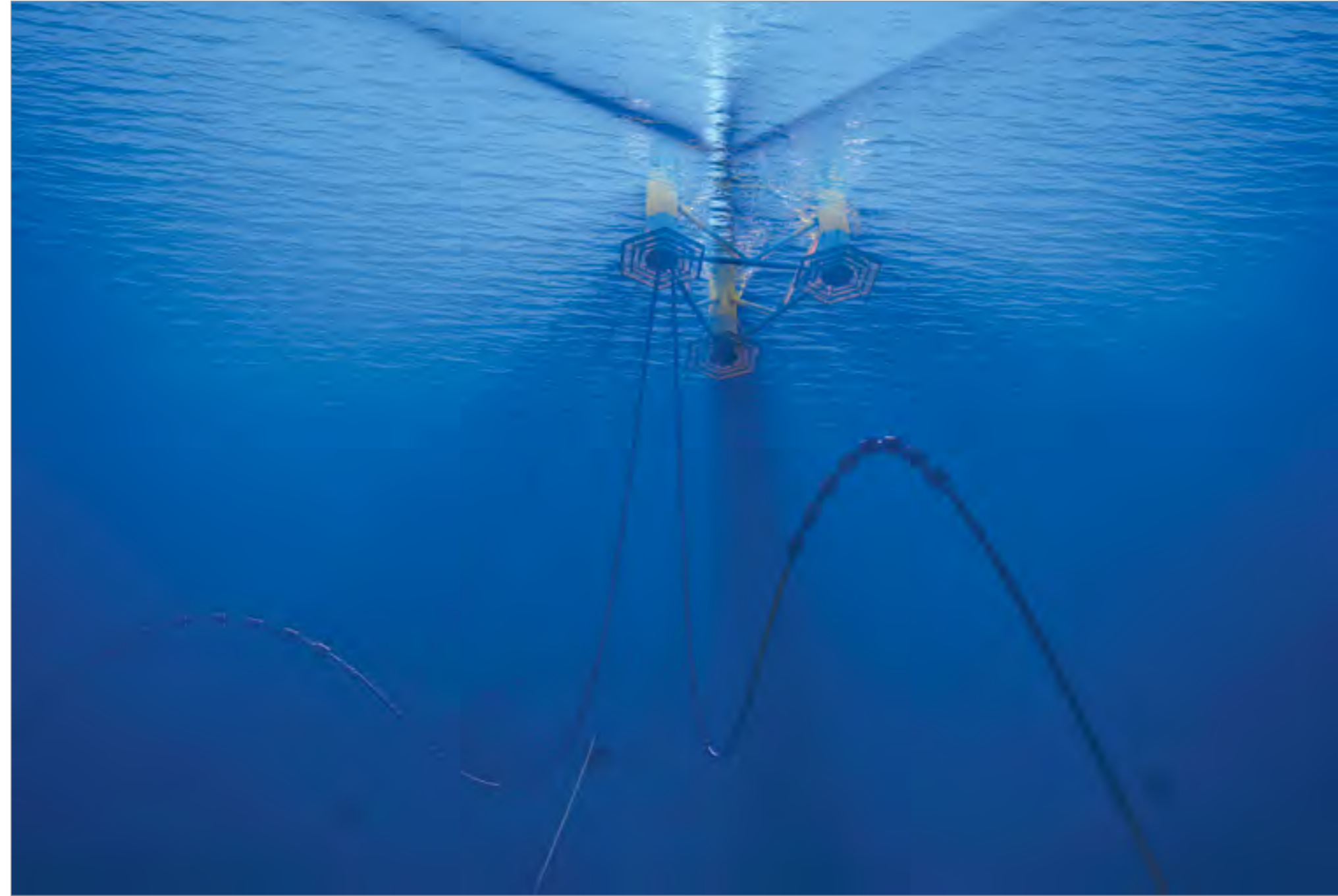





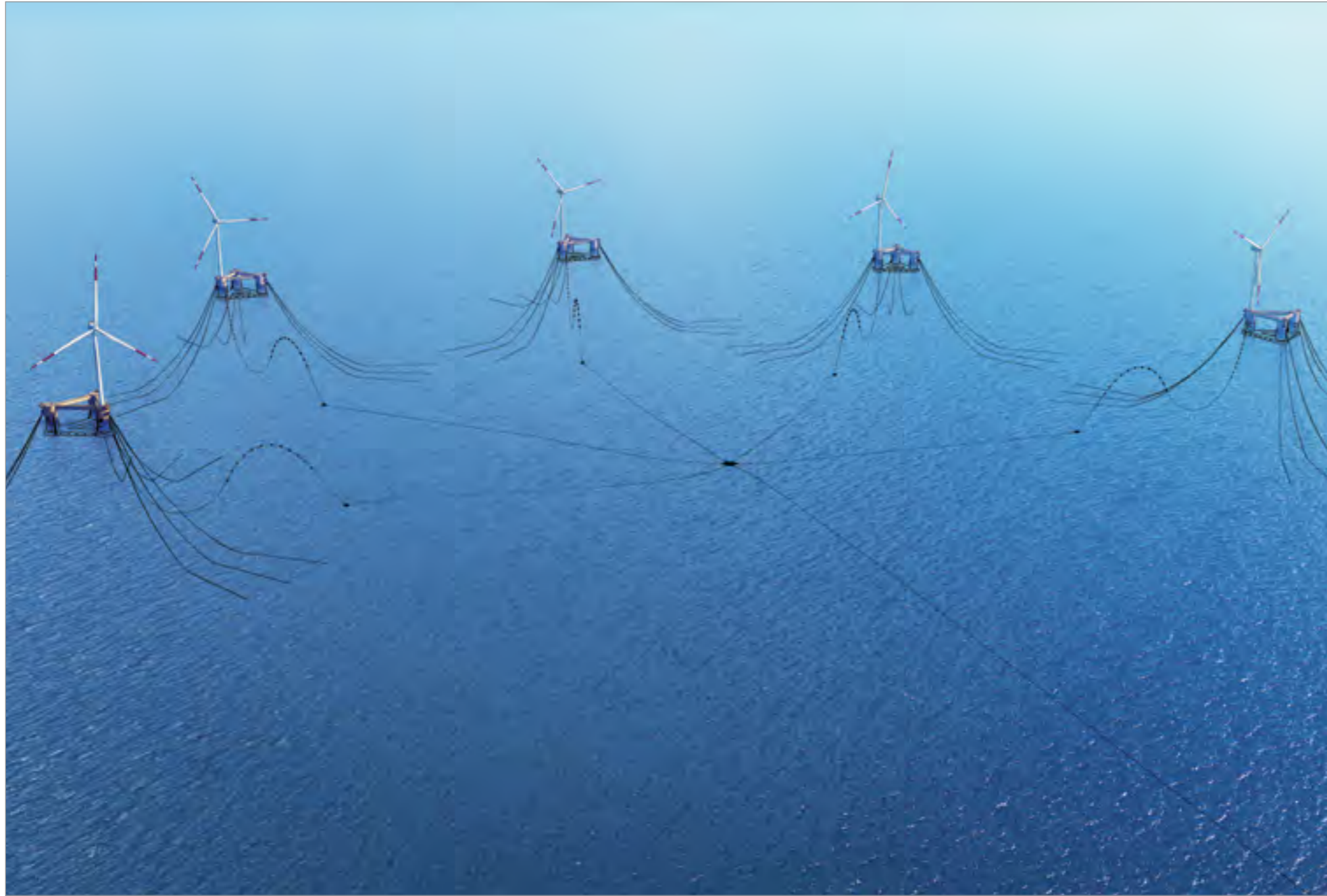

Relationships Matter

Relationships are very important to us. We strive to build meaningful, real relationships with our customers, and our community. We believe one should seek first to understand then to be understood. When we meet you, we treat you like family. We believe in doing what's right, even when no one is looking.





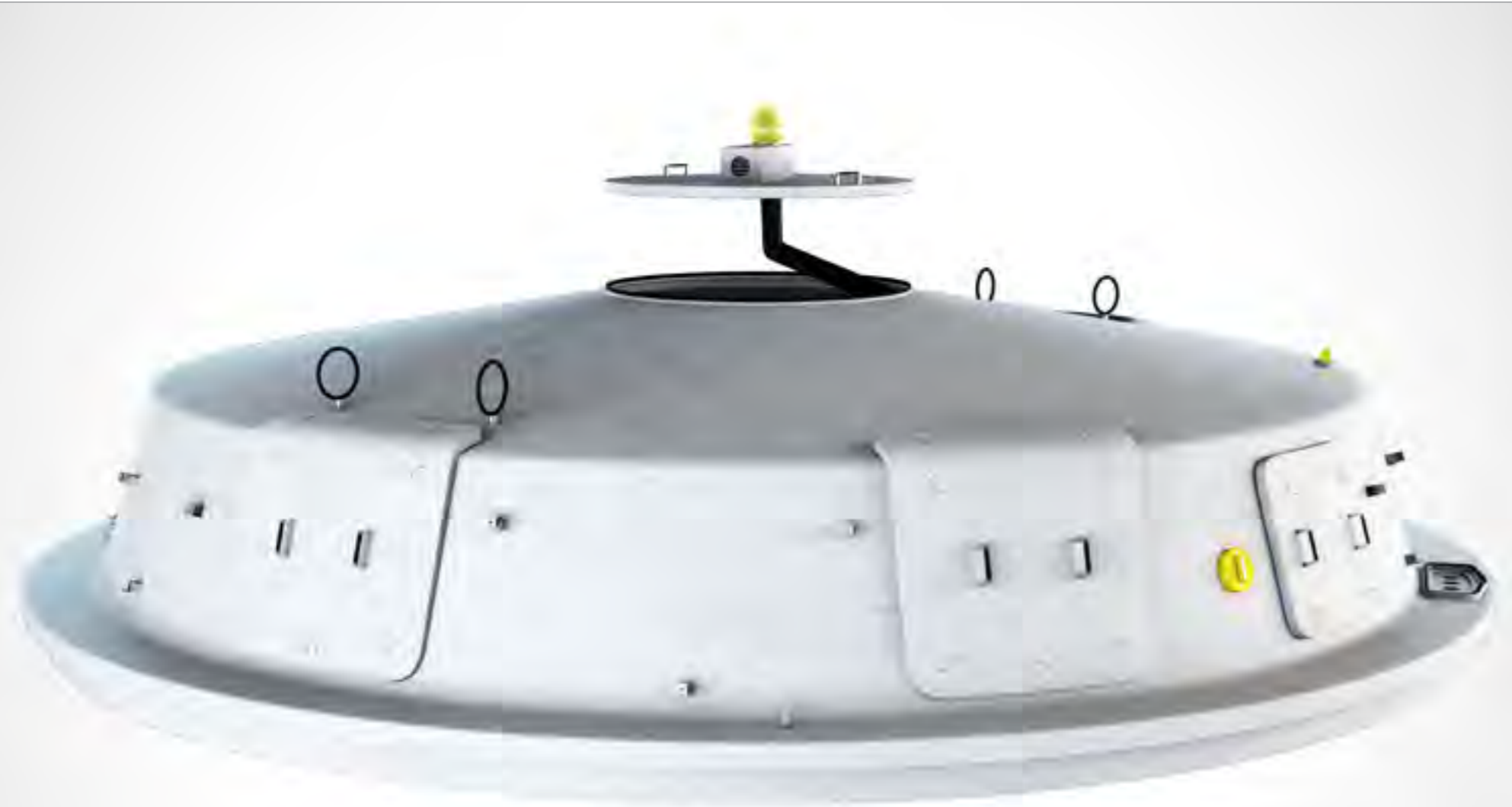

We study what needs to be communicated, understand it and present it clearly and succinctly. We develop visuals and sound to engage an audience, capture imagination and encourage thought.



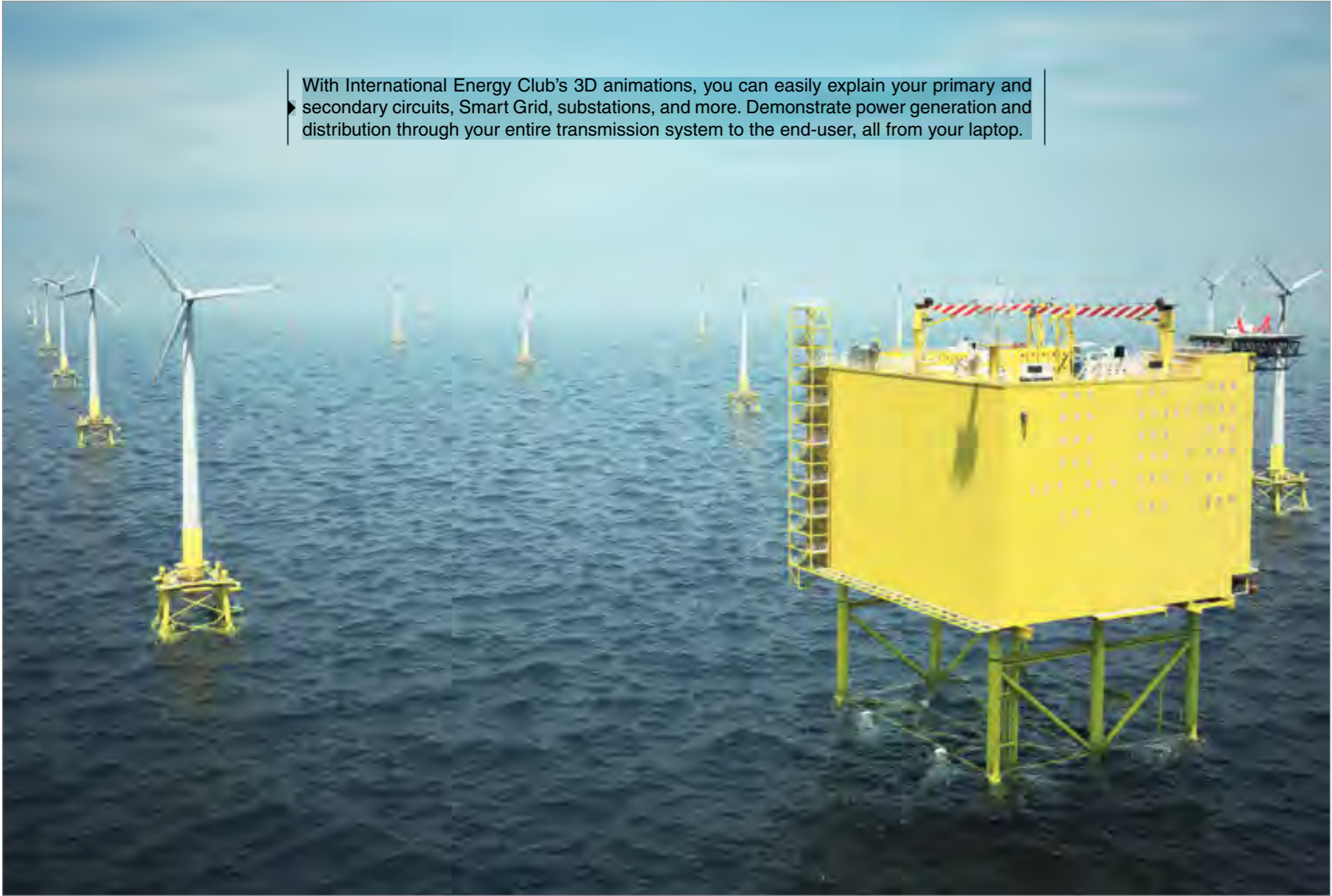

Image Is So Much More Than Information

► Suddenly you see it. That one image. It grabs you and it won't let go. That is what image does to you. Image is taking over the internet. It tells your story faster, more convincingly and with more impact than you could. Image adds emotion and conviction.



With International Energy Club's 3D animations, you can easily explain your primary and secondary circuits, Smart Grid, substations, and more. Demonstrate power generation and distribution through your entire transmission system to the end-user, all from your laptop.



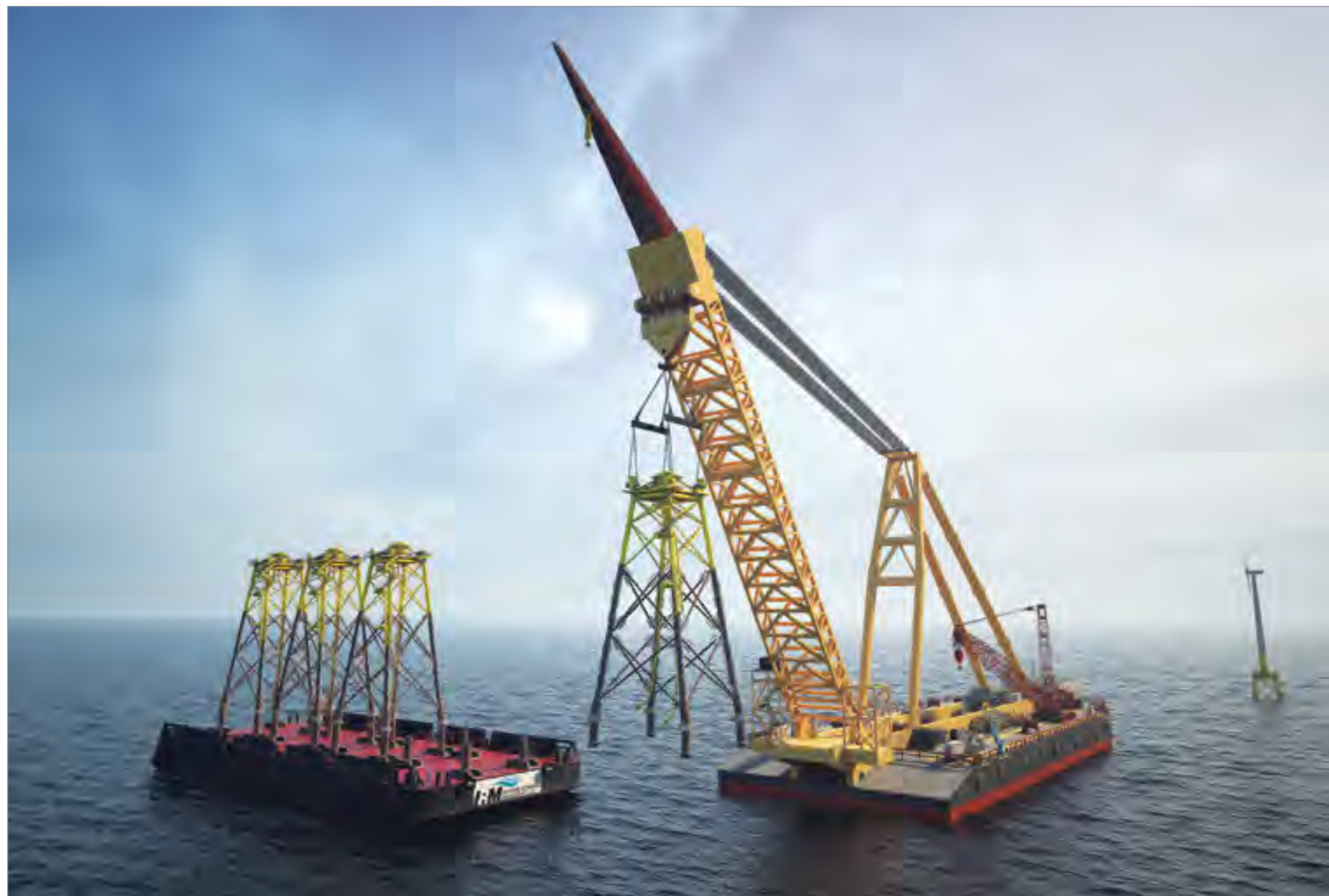





We Have Developed Thousands Of 3D Models

As you have seen in our company profile up to here, over the years we have developed thousands of 3D models. We can use these to add a level of detail to your project without adding additional cost to your project. Hence, When it comes to creating eye catching- serious illustrations or animations, we probably do it and we also do it better and faster than anyone else.









We Can Design Every 3D Model Only From The Pictures

At International Energy Club our artists have the technical knowledge to turn your engineering industrial designs into a 3D model. This helps you to plan up and achieve your plans and also helps you to communicate better with the construction companies involved using our industrial animation. In fact our artists have the experience to create anything into a 3D structure. We can also add realistic water, steam, motors etc. to achieve reality in our 3D industrial animations. these two pictures here and many more in other pages of this profile are good samples in this regard.

We Power Possibility

We are some of the world's brightest 3D specialists in the offshore, marine and renewable energies, all working to deliver a more sustainable world. In fact We are a worldwide team of consultants, engineers, and 3D specialists, all with one thing in common: we love to be challenged. Every day, we come to work to create world best 3D animations for our clients in the offshore, marine and renewable energies.





Professional Animation Creates A Remarkable Brand

Animation is great for promotion. Using the technology and imagery, firms could explain the goal of their business very well. A well-made video animation will stick to their minds for a long time and will make a remarkable brand. Thus, it will create individuality and amplify uniqueness.



Boosts Your Business Reputation

Using a 3D video animation adds a stunning impact and portrays realistic effect to your business. It inspires visitors with the visual appeal and engage them to watch your video and improve your traffic. A compelling video boosts your business reputation and elevates your image in the market among customers. It leaves the lasting impression on the audience and draws their attention.



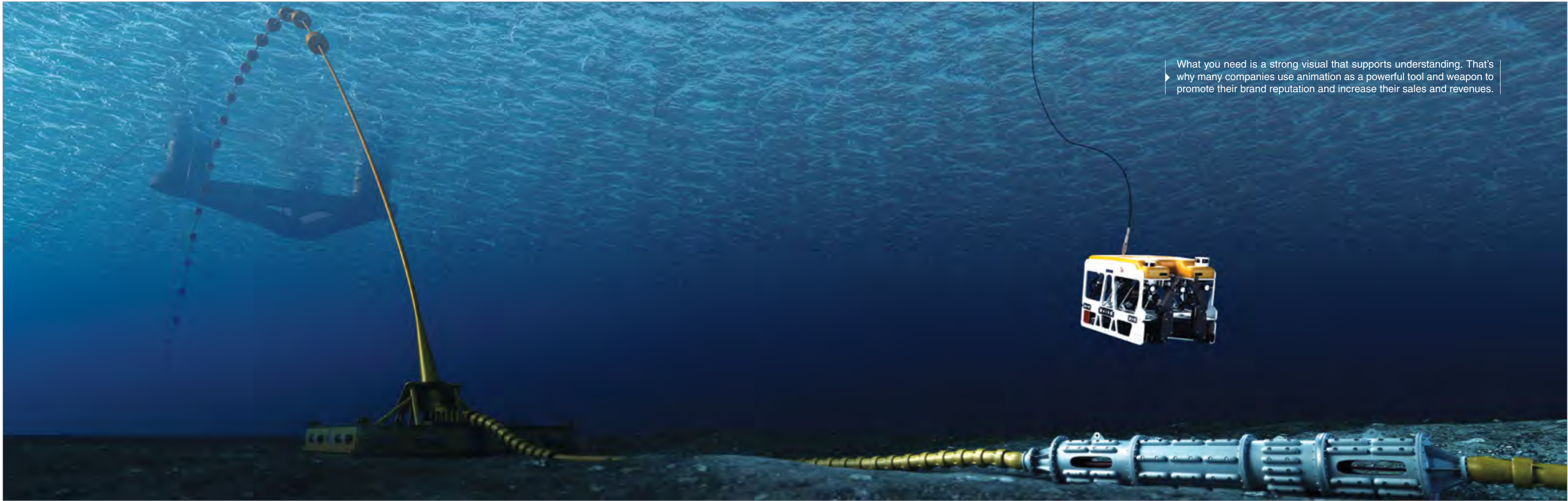

What you need is a strong visual that supports understanding. That's why many companies use animation as a powerful tool and weapon to promote their brand reputation and increase their sales and revenues.

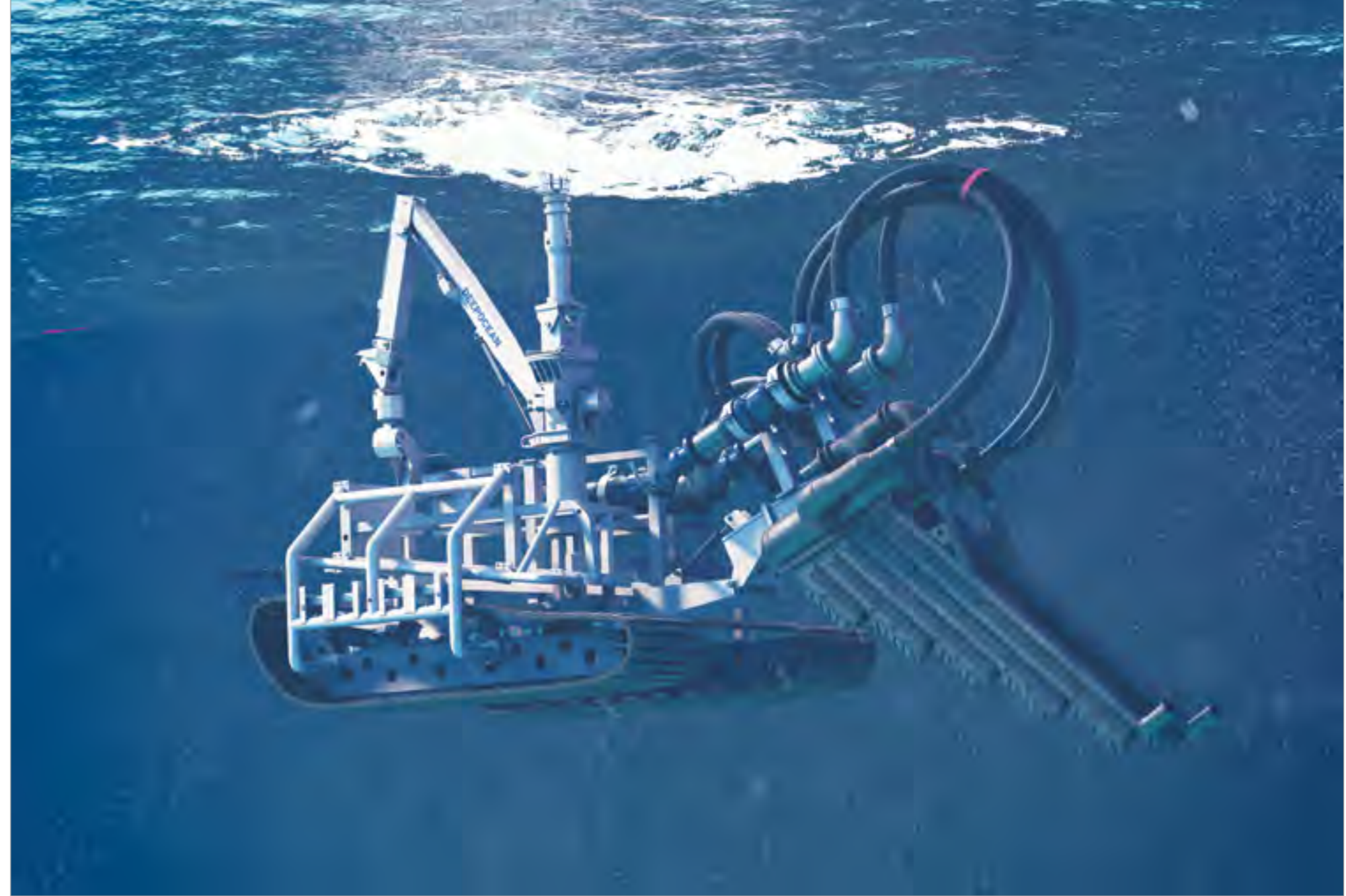

We Have The Expertise You Need

If you're from an agency that's looking for an efficient and creative production team, we have the best track record you could want from a partner.





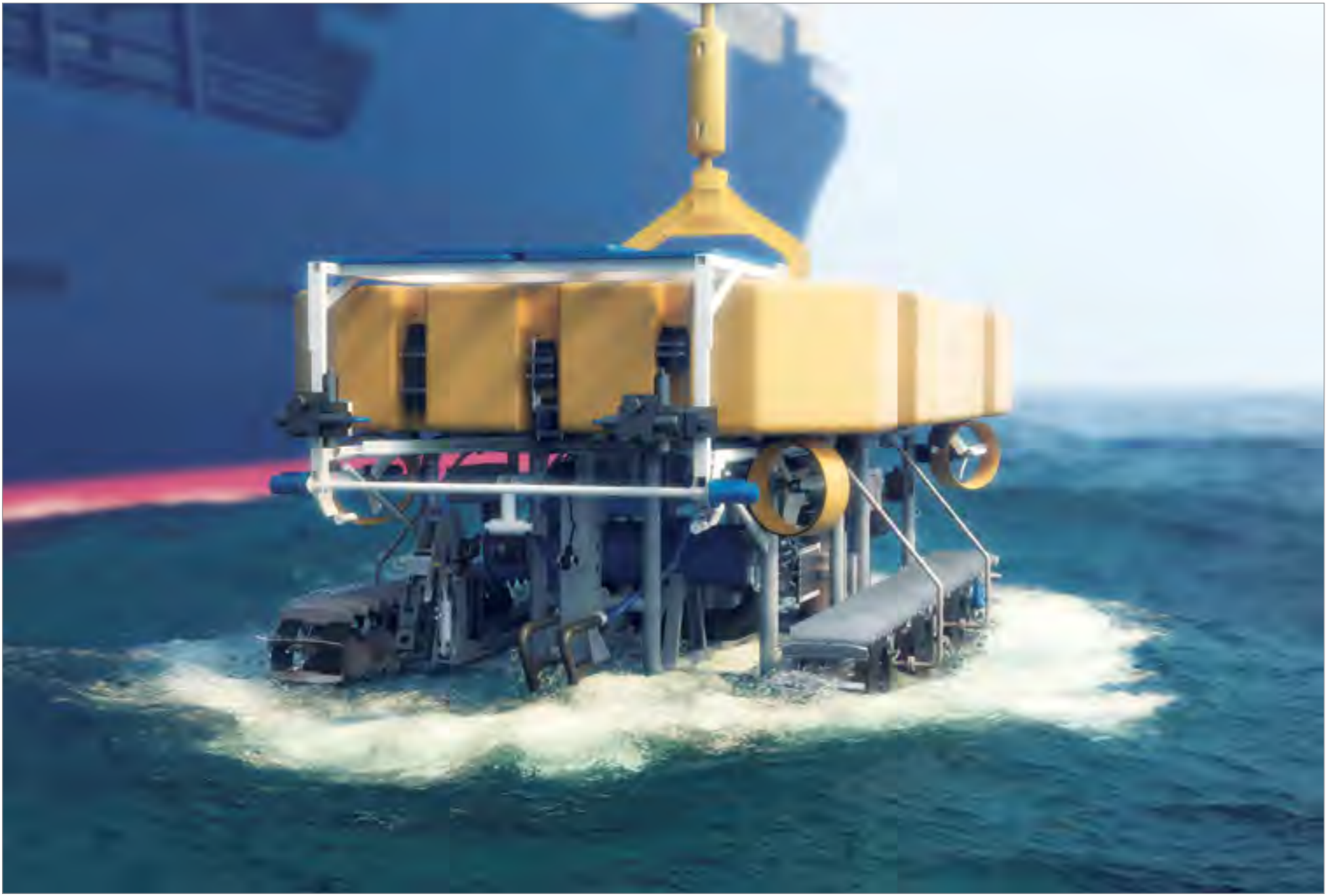





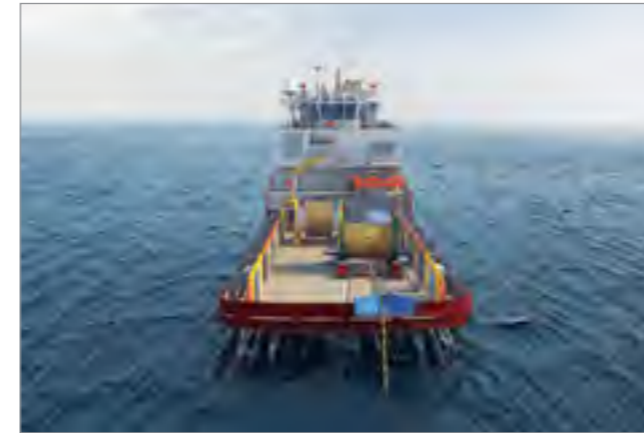

Imagination Exceeds Expectation

▶ One of the advantages of creating 3D animation videos is to visualize and think of imagination that exceeds your expectations. It all requires a novel concept and dynamic script to build an actionable video for your target customers. Animation comes to life any virtual idea and turns it into reality. They are engaging and fun-loving and give viewers an amazing experience to watch them.

Animation Can Save Money & Time

Being able to see the design in 3D animation gives engineers the ability to modify and improve their design before sending it for the final manufacturing process. This can save huge amounts of money and time.



You can rest assured, you'll never lose a file with us and your privacy will always be respected.





▶ 3D is a format that allows your marketing to be as unique as your business. |

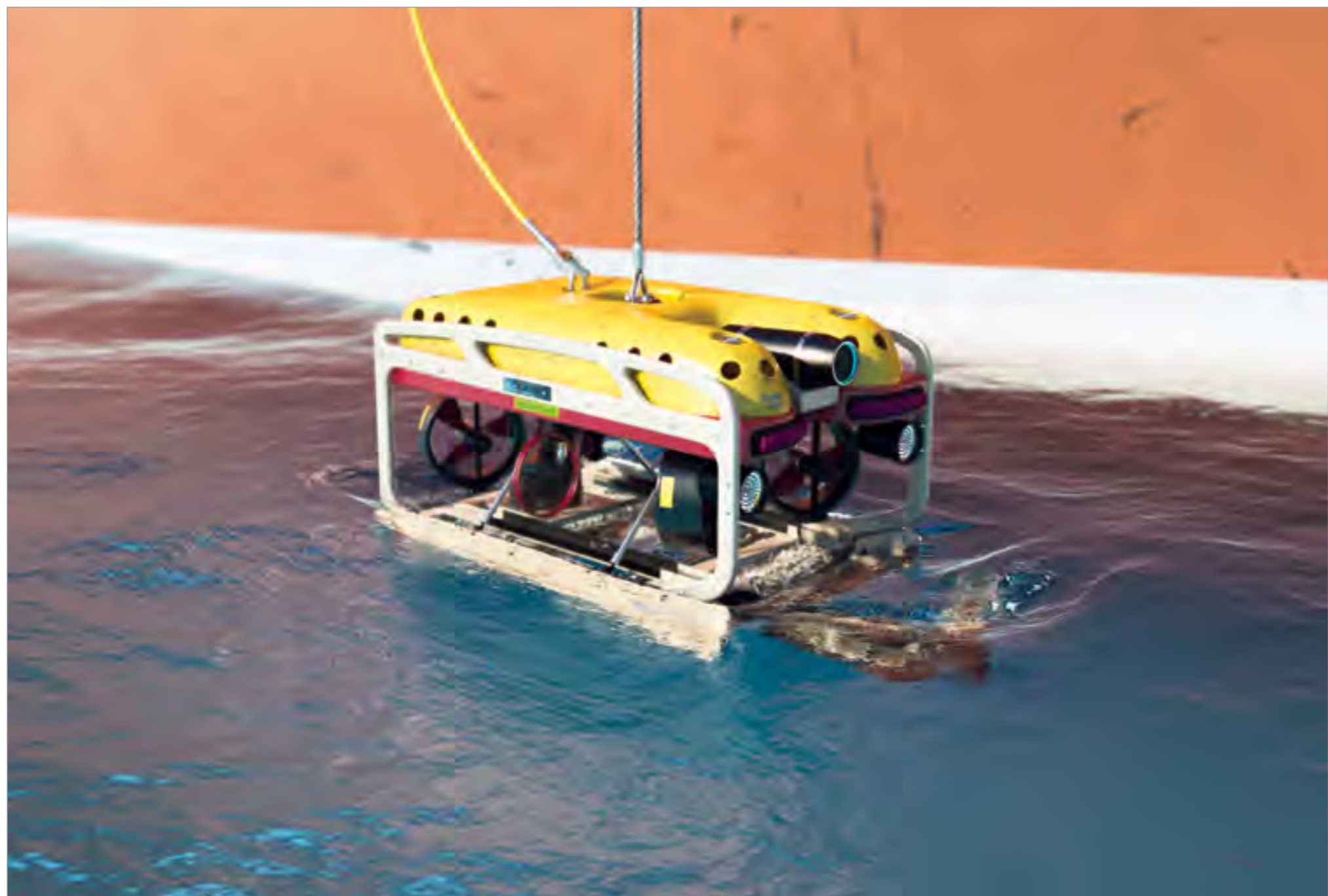



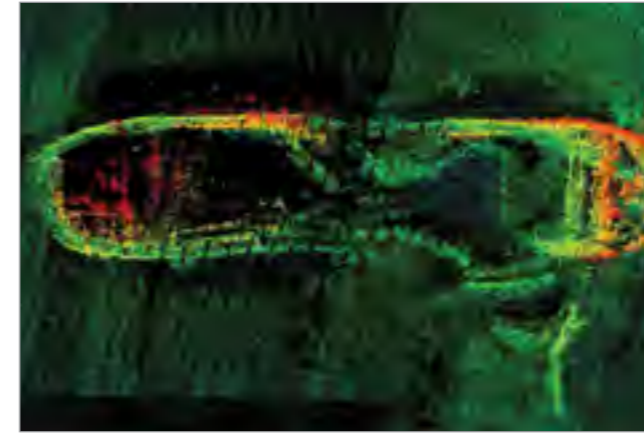
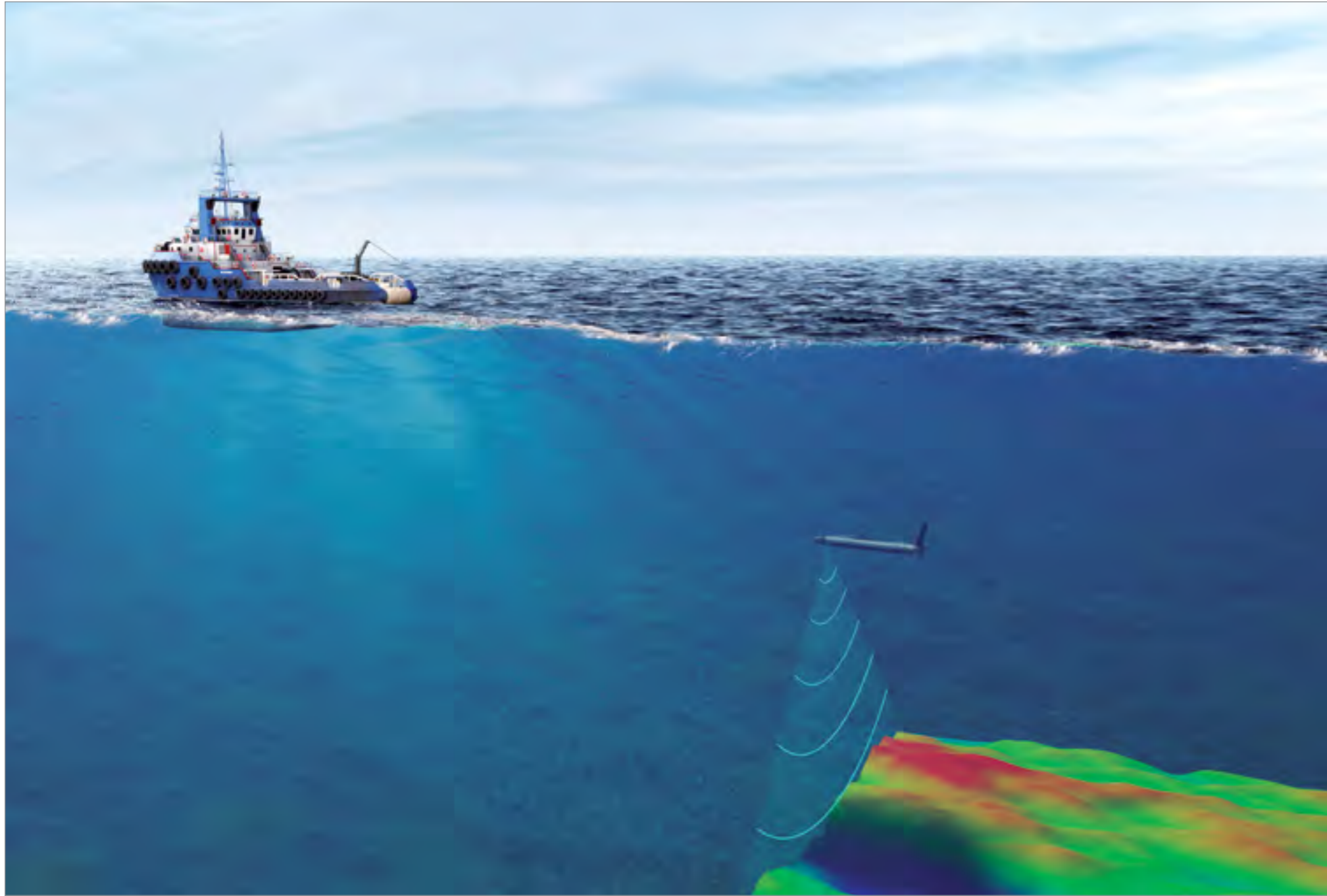

We Bring Technology To Life!

3D animation is perfect for bringing technology to life, capable of detailing intricate procedures and demonstrating the inner workings of complex machinery. We pride ourselves on producing beautiful video animations that capture the imagination and have vast experience of transforming complex material into engaging visual content, often using video animation to guarantee a superior level of clarity for products that consist of complicated mechanics.

We Show Your Vision For The Future

► We see our job as provide a portrait for others to be able to see your vision for the future... and to have them embrace the potential of what "could be". We pursue photo-real animation, web and interactive worlds to present your dream in a whole new way. International Energy Club's desire is to propel you to a whole new level of casting vision and pursuing your own dreams for the short and long-term future.



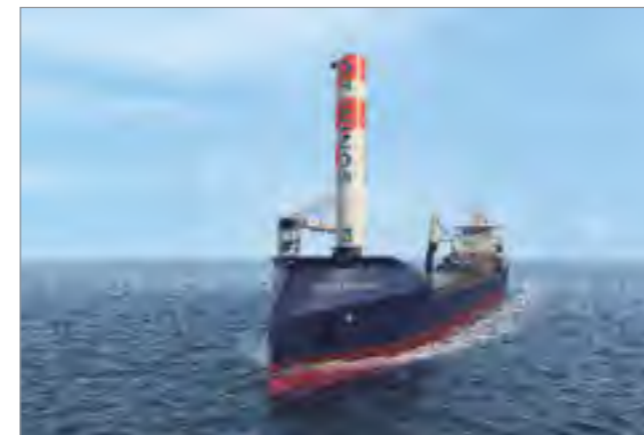
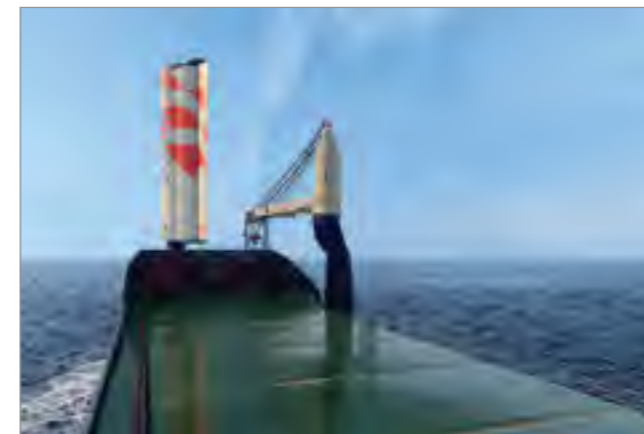

We Are Always Preferred Partner for ongoing and future projects of Our Clients

At International Energy Club, our commitment to excellence and attention to detail has led to long-lasting partnerships with our clients. Most of our clients, impressed by the high quality and precision of our animations, choose us for their subsequent projects. Our ability to consistently deliver outstanding results, coupled with our friendly and collaborative approach, fosters strong relationships built on trust and mutual respect. This close rapport ensures that we not only meet but often exceed our clients' expectations, making us their preferred partner for ongoing and future projects.





We Have Never Met Many Of Our Clients Face-To-Face

We have never met many of our clients face-to-face — a testament to the confidence and comfort they feel in using our services remotely. While we are always glad to meet you face to face, you can still put the best visual communicators in the industry on your team cost-efficiently and conveniently. If necessary, we will maintain close communications with you throughout the entire development process via teleconferencing, Internet communications, and file transfers.

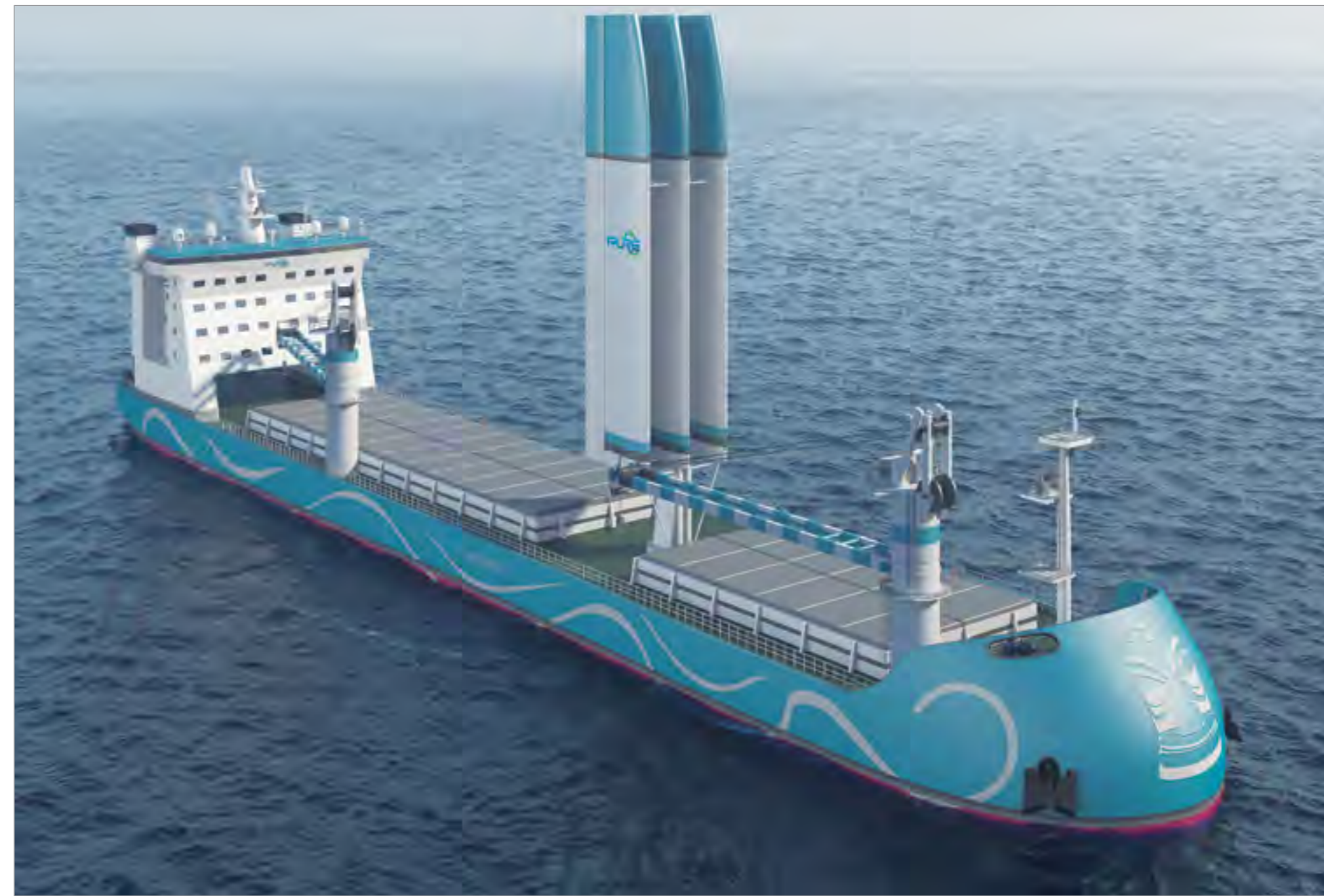

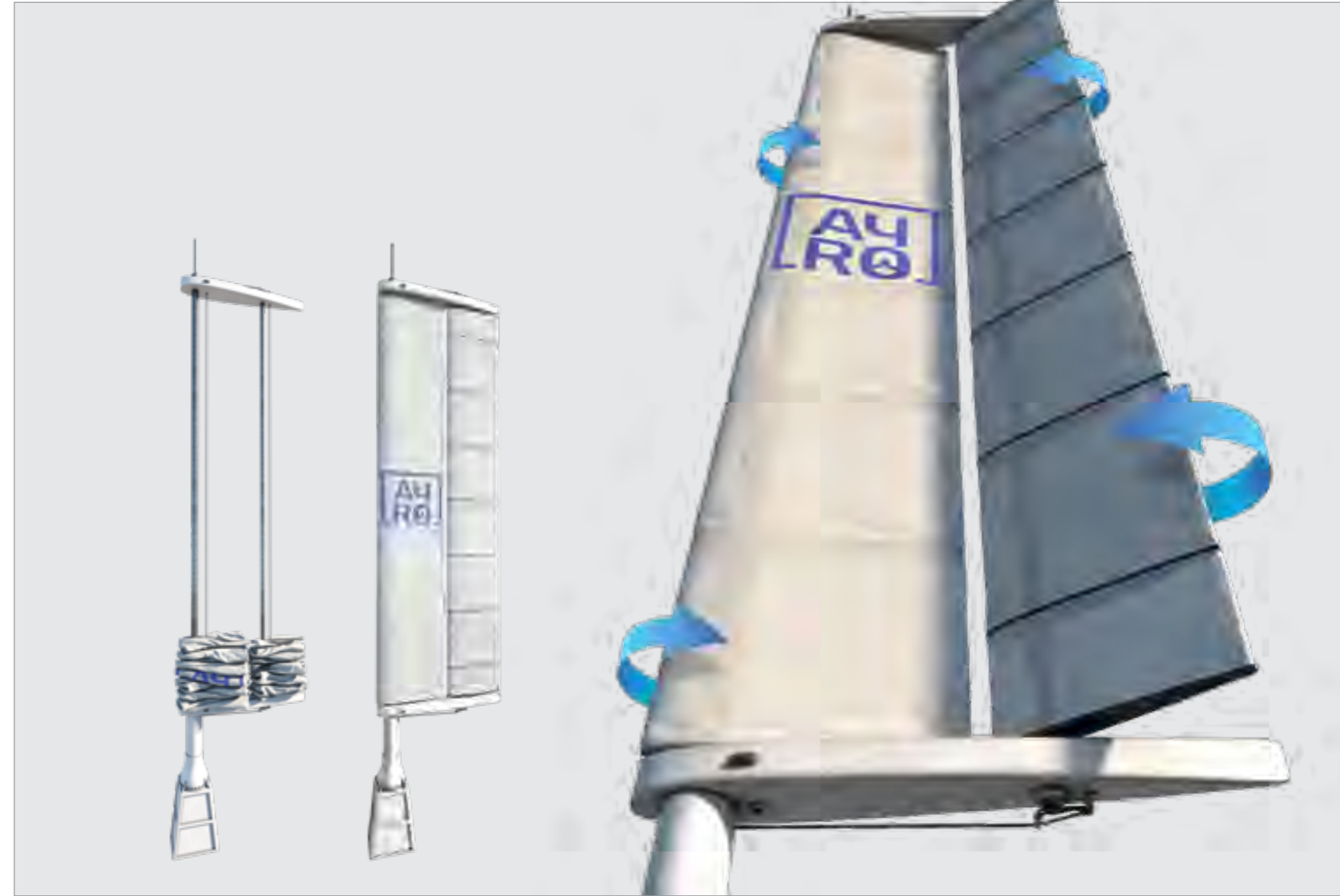
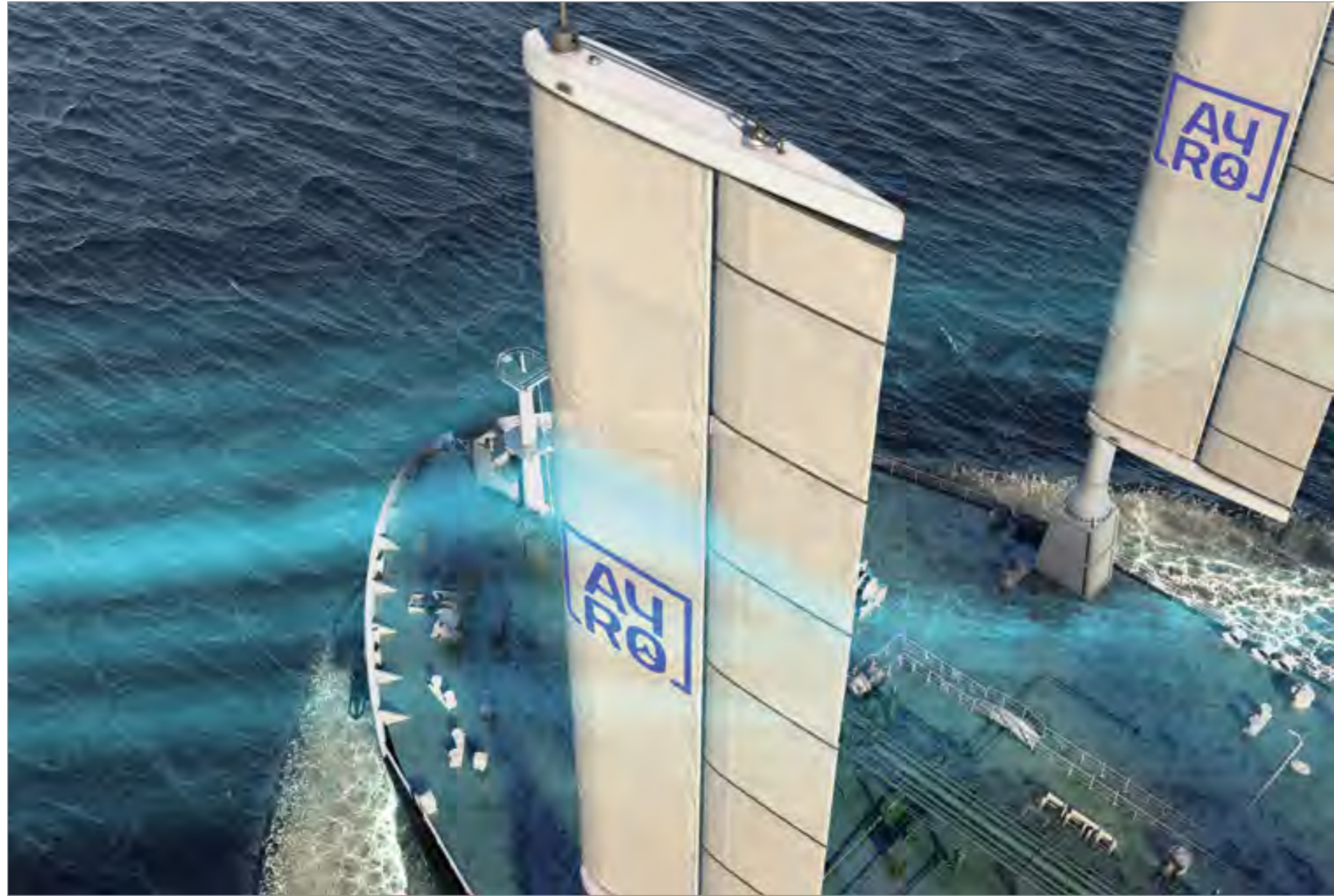





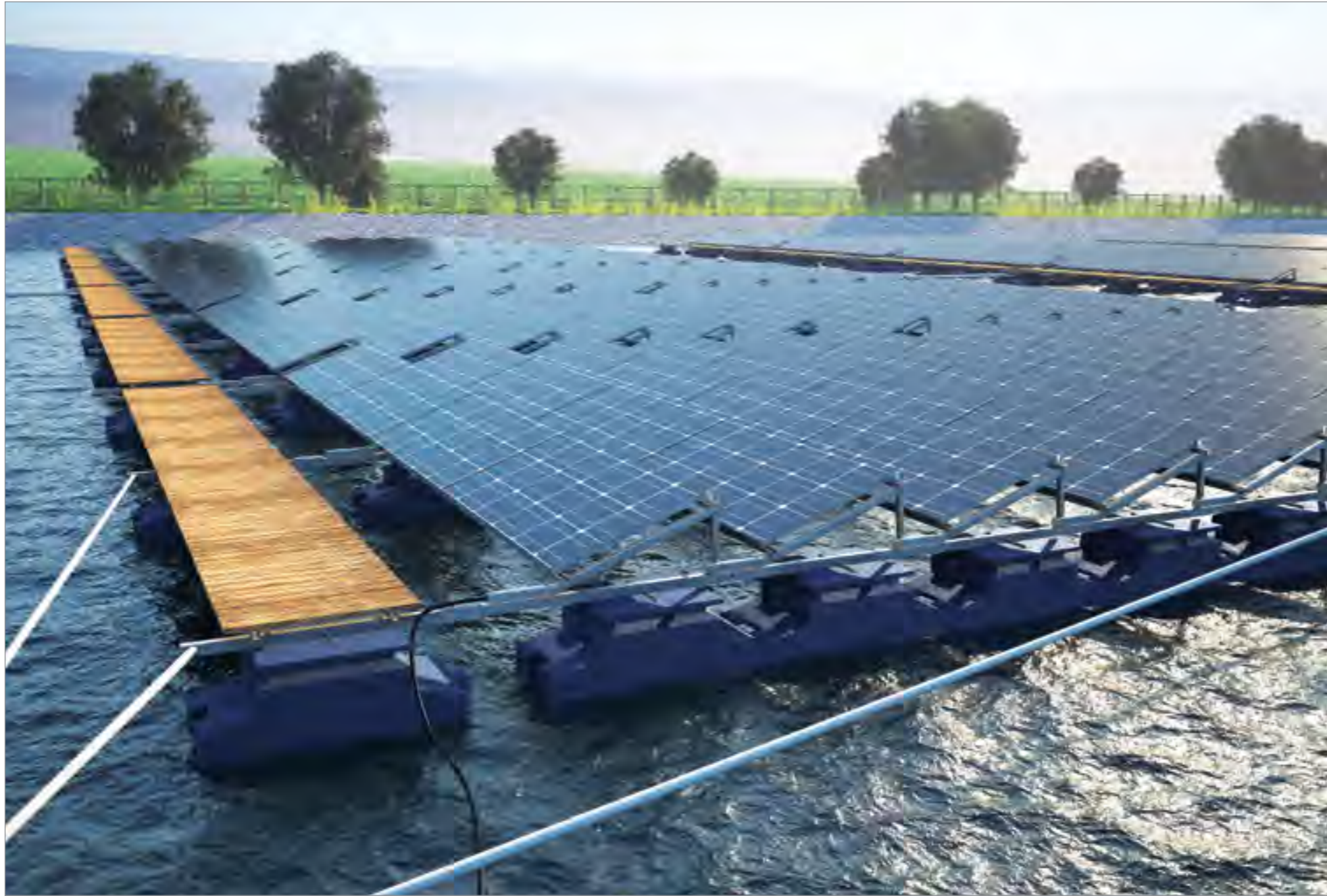

Why Choose Us?

▶ We provide a complete end-to-end 3D animation service for technology, engineering and manufacturing sector companies. Every production aspect is covered - script writing, 3D modelling and rendering, editing and soundtrack. We liaise with clients throughout the entire process so that you can be sure of an excellent end product with a first-rate service that perfectly fits your needs.

Why Video Marketing?

Video marketing is one of the most effective tools in the world of digital marketing. It provides video and audio elements telling the whole story. It is beneficial in increasing learning and offers a more memorable experience for the viewer. It drives engagement that promotes conversations. The visual aspect of video makes it easy for consumers to understand exactly how a product works and the benefits it offers. Additionally, video is sharable across a wide variety of platforms including the web and social media channels. This makes it a cost-effective marketing option.



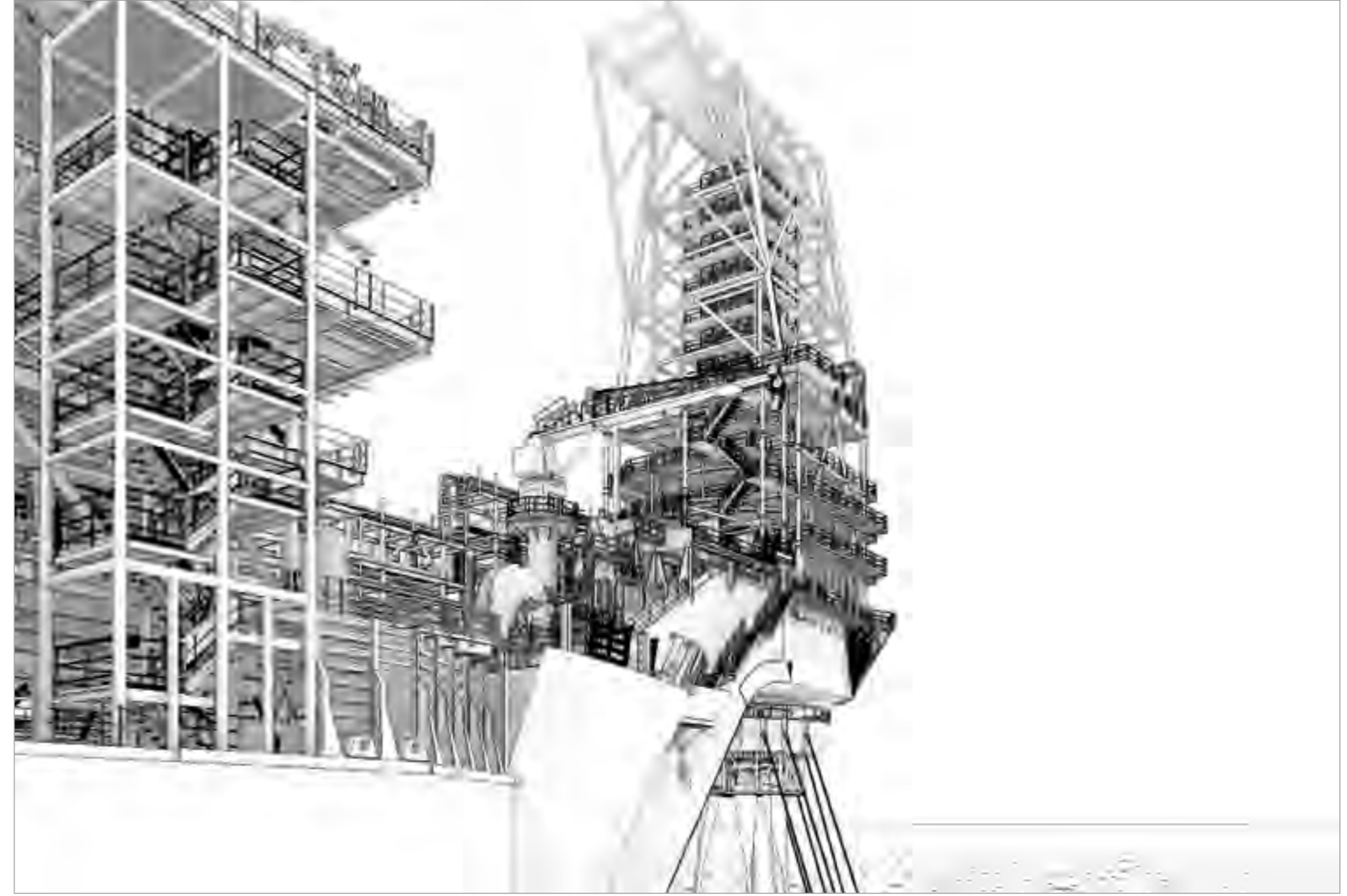

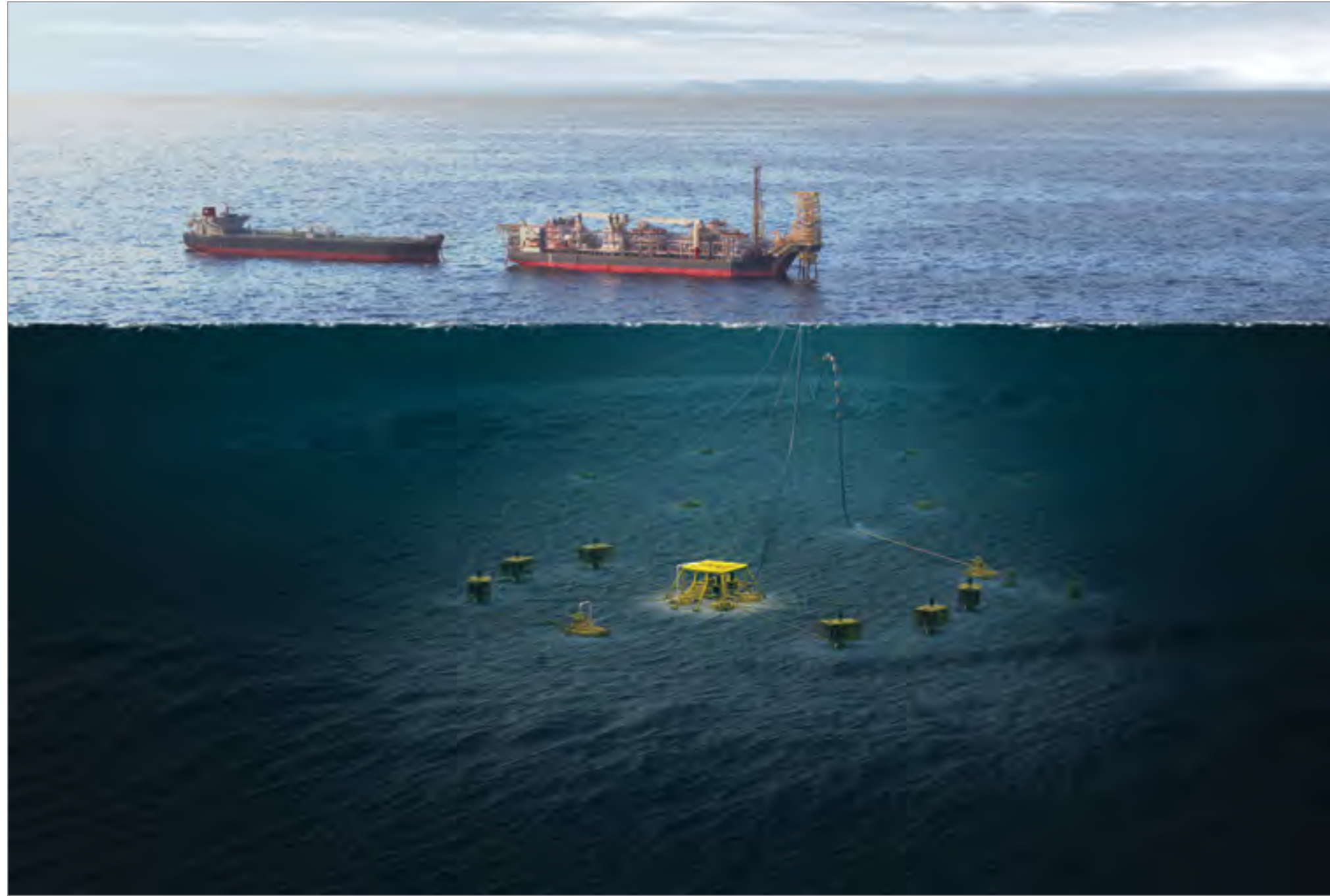

Do you have something complicated to say? We think you should explain that in a simple way. Through animations. Animations are accessible, understandable and educational.





| If You Need **Digital Magic**, You've Come To The Right Place

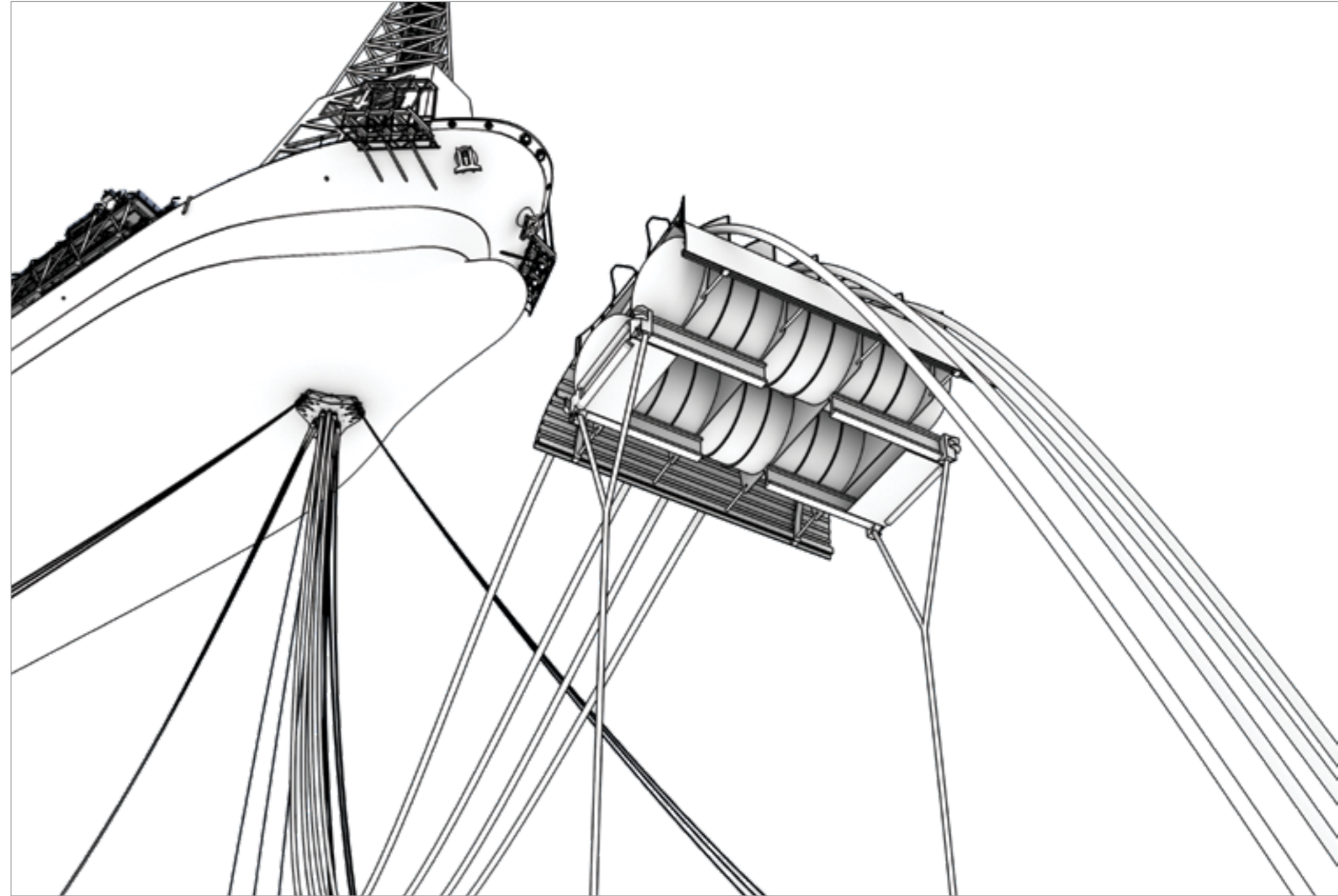
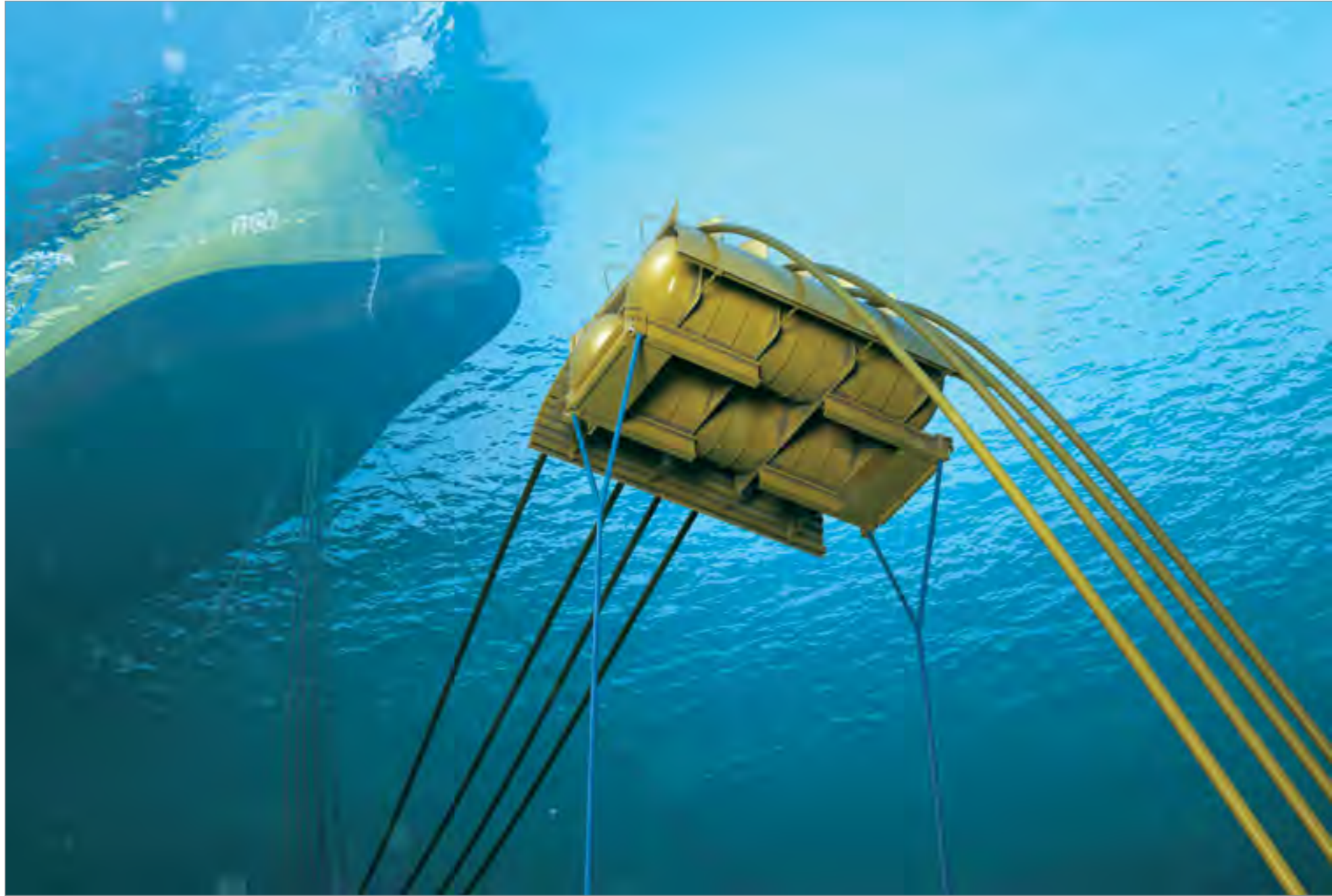

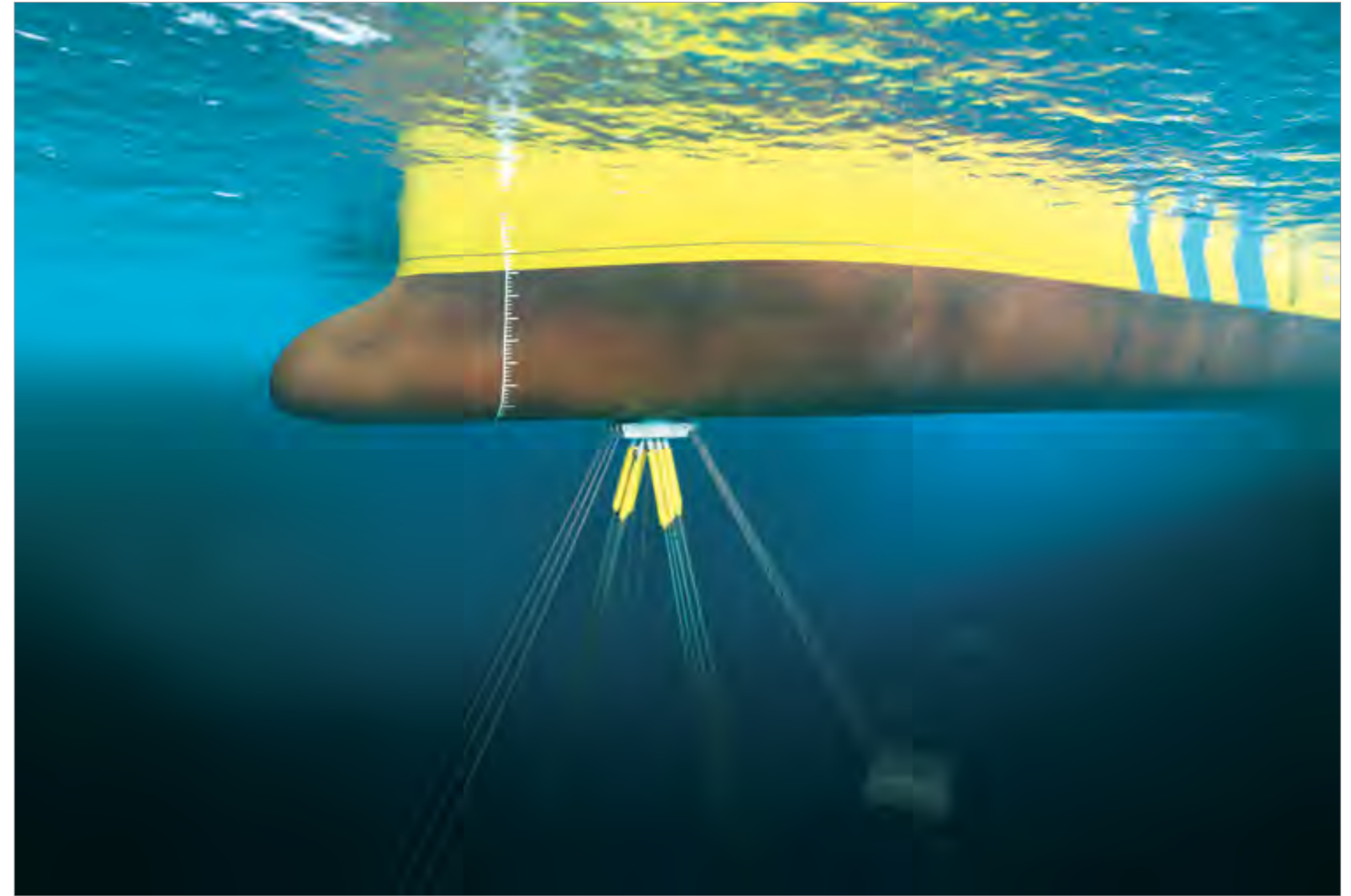

Think Outside The Box!

Always strive to “think outside the box”, and are dedicated to improving the quality of everything around us. Nothing is ever finished, everything can be improved. Always searching for new ways to refine our existing process and procedures so that we can improve the overall experience for our customers and our associates alike. We’re very curious by nature and are inspired by technology. We are always looking for ways to use technology to speed up our own processes and make our customers lives easier. Wanting our customers to feel a difference and experience our exceptional customer service, nothing makes us happier.







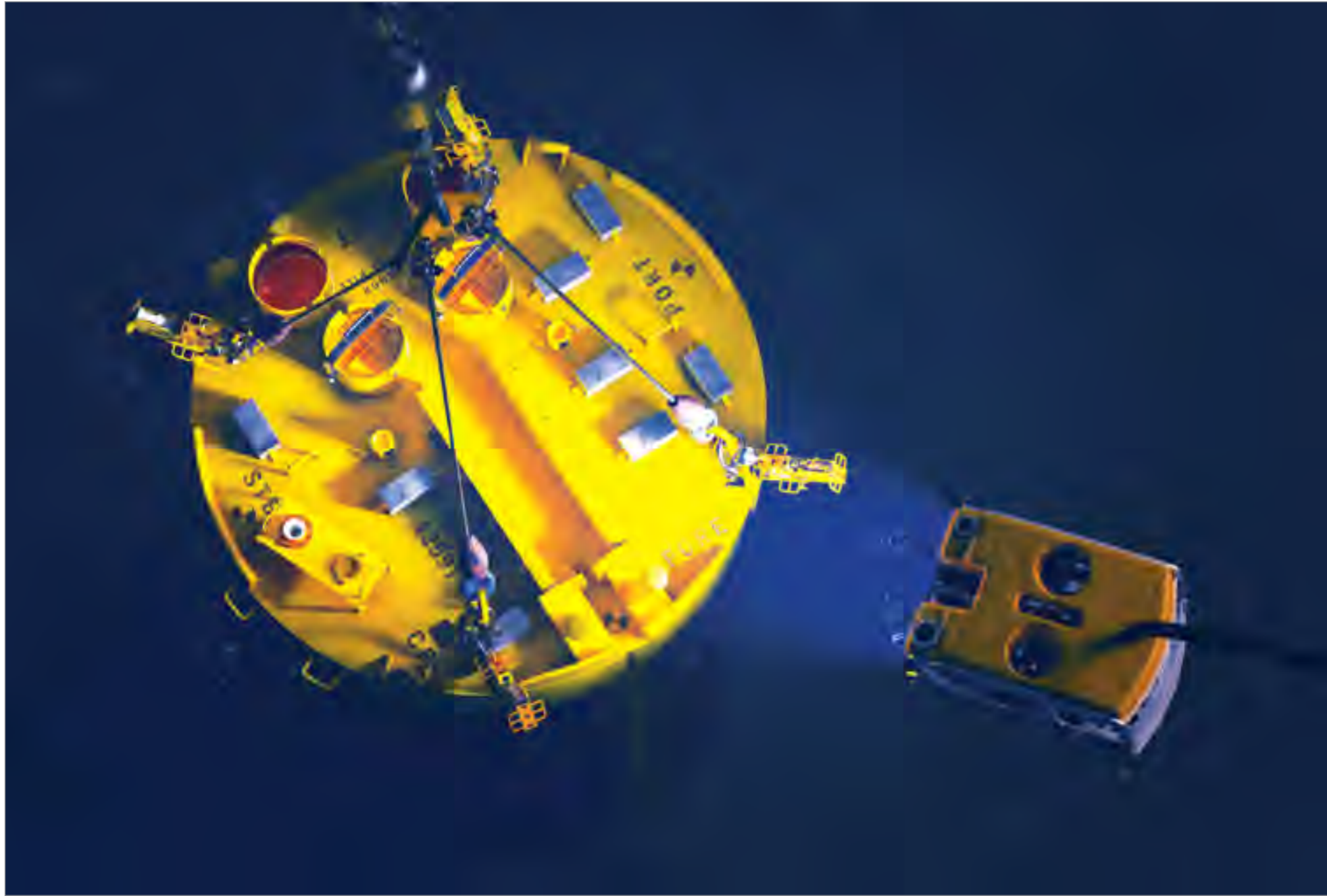

We Are Where Great Minds Meet

We are best known in the world for our work in creating technically-accurate, industrial 3D animation in the field of offshore, marine and renewable energies. We are well versed and devoted to delivering exceptional work for our clients. When you have complicated projects, you can count on our team for visualizing complicated scientific processes in a clear and accurate way.

| **One Look** Is Worth A **Thousand Words**

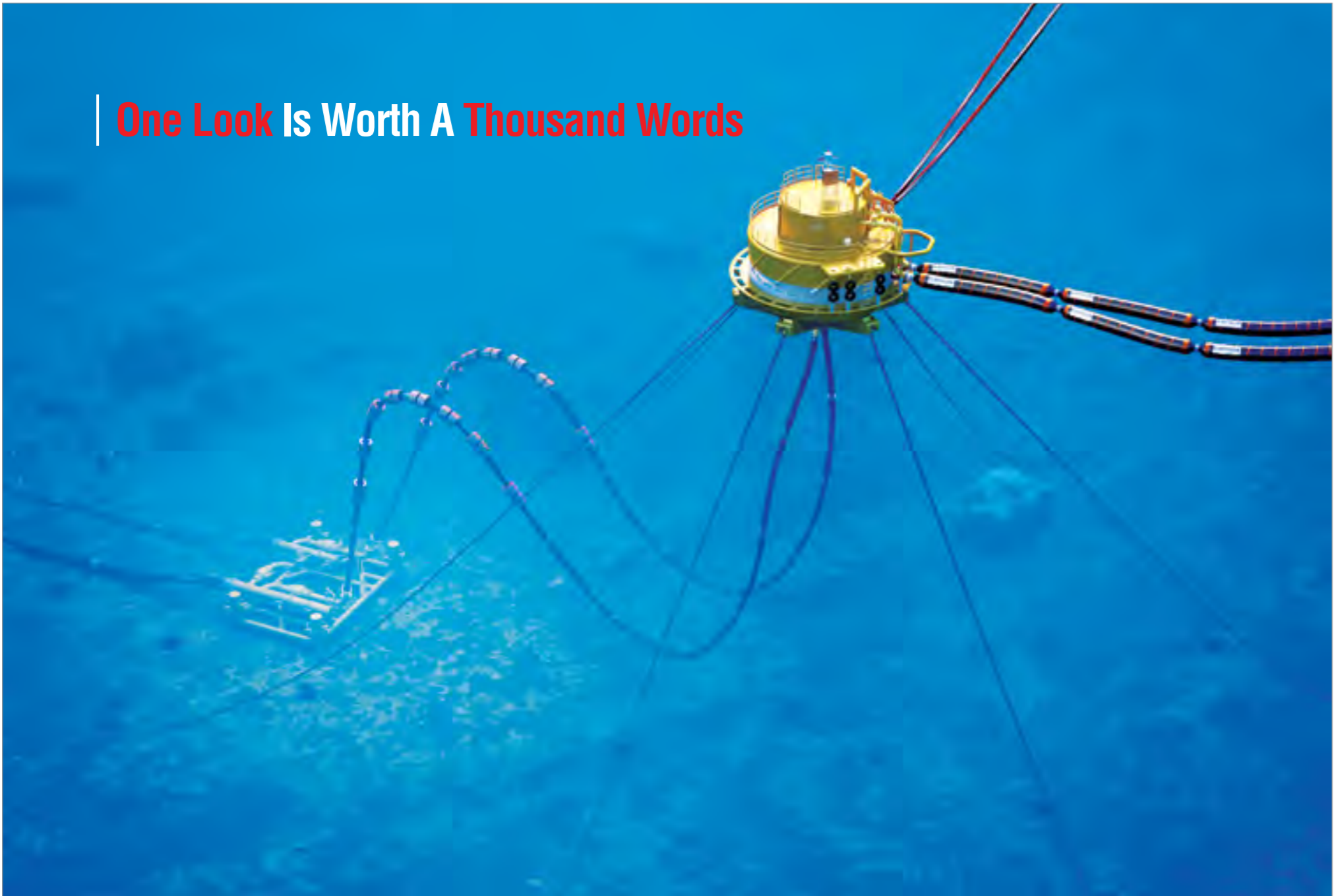

A Good Product Deserve A Good Presentation Too

Your product deserves the best presentation and International Energy Club is the best 3D animation company for your needs. 3D Animation is a great way to let the product present itself. Especially if you use the animation on your website and on social media. Animating your product in 3D is an easy way to create great content that engage your audience and ultimately affect sales positively.



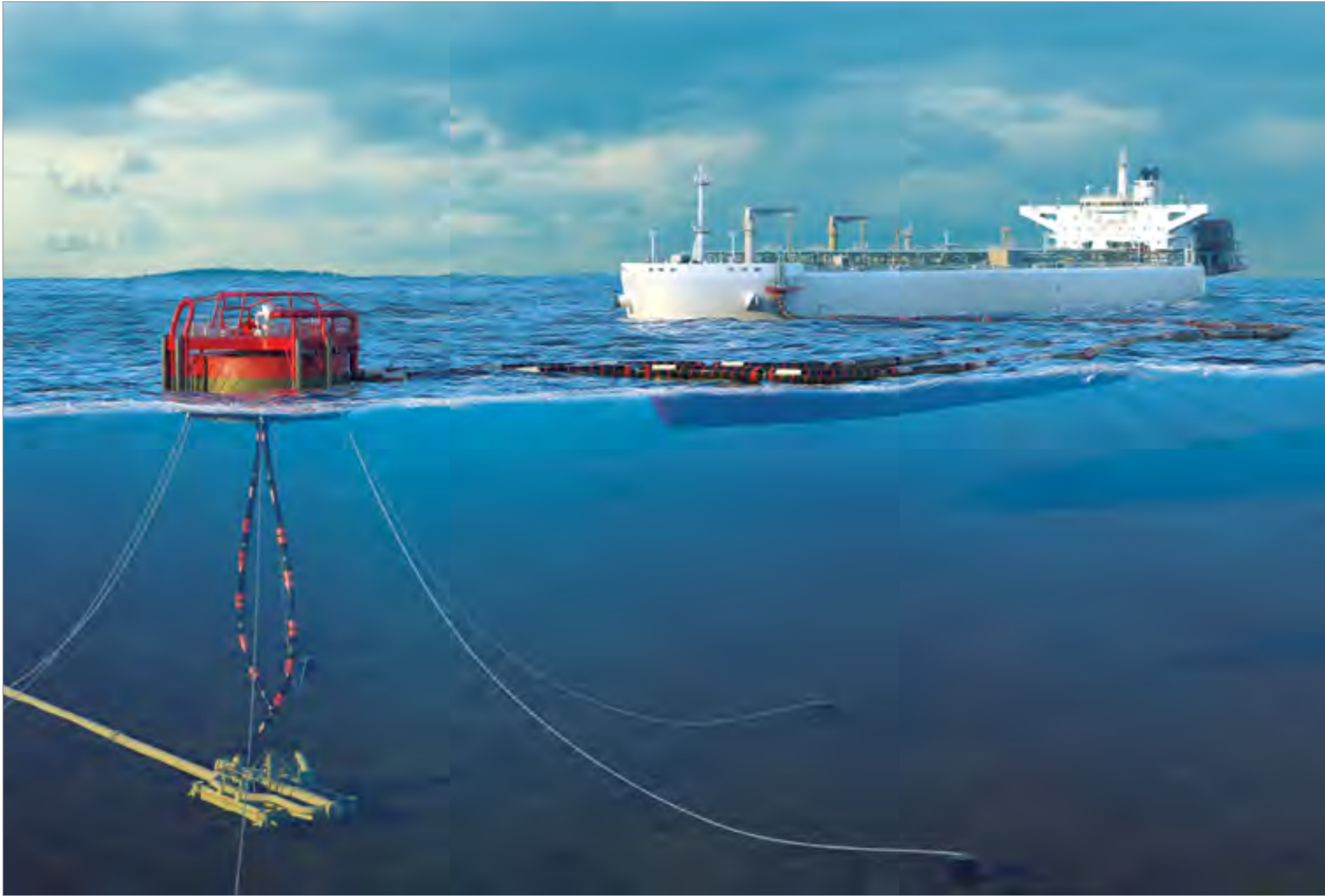

With The Right Eye-Catching Video, We Can Draw Attention To You

▶ We've all walked the trade show floor, passing booth after booth, eyeing the tables to see if they have any good swag but generally skimming the crowd for something to catch our eye. Of course there are going to be the big companies there with the huge budgets who make a splash with a fancy booth, but we've found that with the right eye-catching video, we can draw attention to you whether you are the billion-dollar behemoths or the mom-and-pop shop across the aisle.





We Care About Details

We apply the same attention to details and standards of quality against every project that comes through our doors, no matter how big or small the project and or client may be. In fact we are not concerned about the number of projects we can take on at once and how quickly we can crank them out. Our focus, has and will always remain on the customers and their complete satisfaction. That is why we maintain a small creative team comprised of animators and designers that are among the bests in the industry.

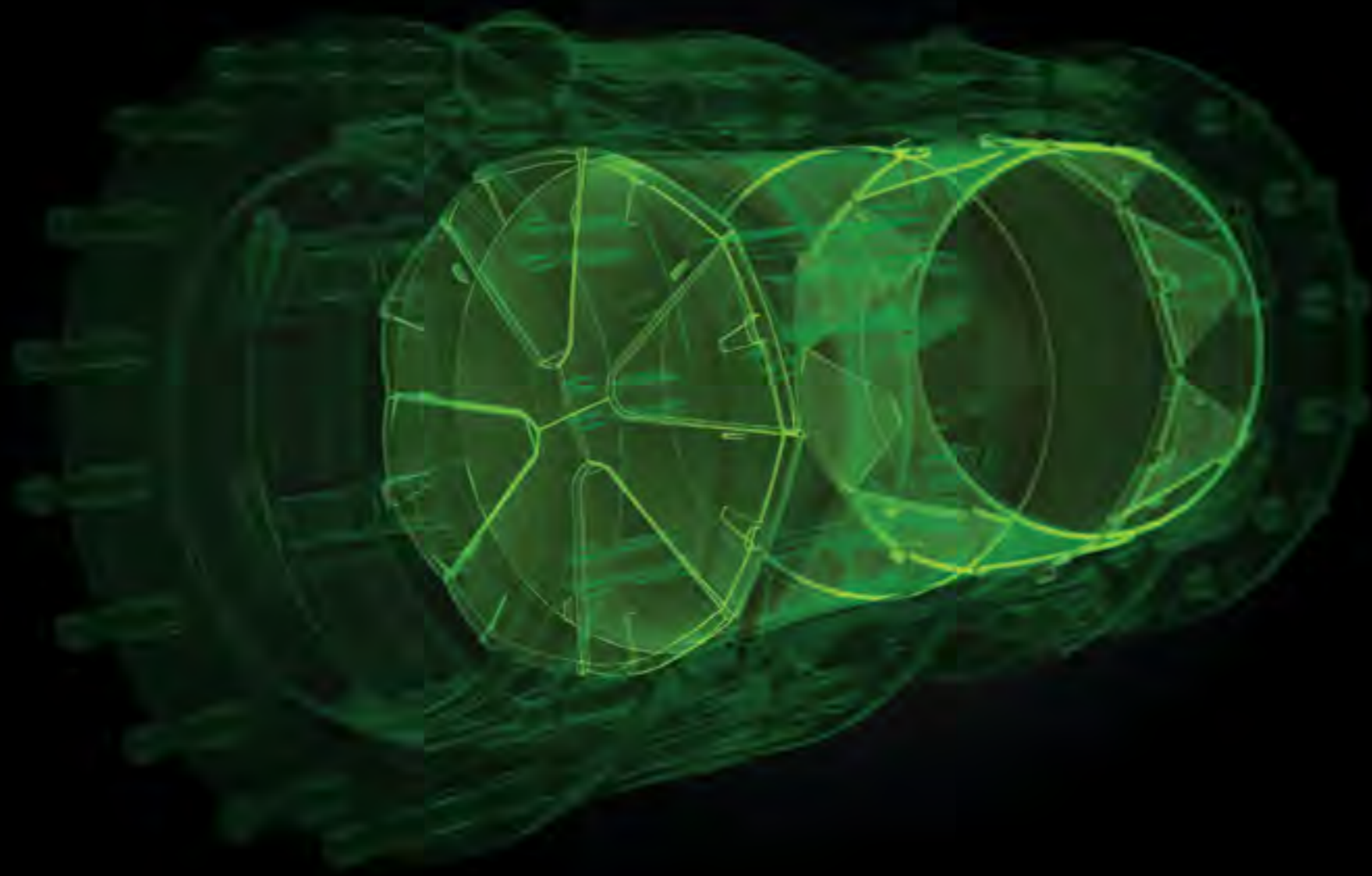



We Have The Background & Experience

Engineers, designers, trainers, technical sales, and marketing teams all use realistic computer-generated 3D Animations and Graphics to bring ideas to life. International Energy Club's client base ranges from corporations to small businesses from across the globe which means we have the background and experience to deliver your graphics efficiently and within budget every time.



We Bring Motion Into Your Booth

You need motion to draw the eye. No one is going to be scanning the convention hall floor and have their eyes land on a text heavy poster hanging in the back of your booth. You need life and movement and something that grabs attention. And you get that through visuals, through animations with action and motion and bright colors. Look, we're not saying you need a Mardi Gras float but you need the trade show equivalent of a Mardi Gras float. You need something that will make people stop walking, take a step toward your booth, and get curious for more—and then your sales people can engage them.



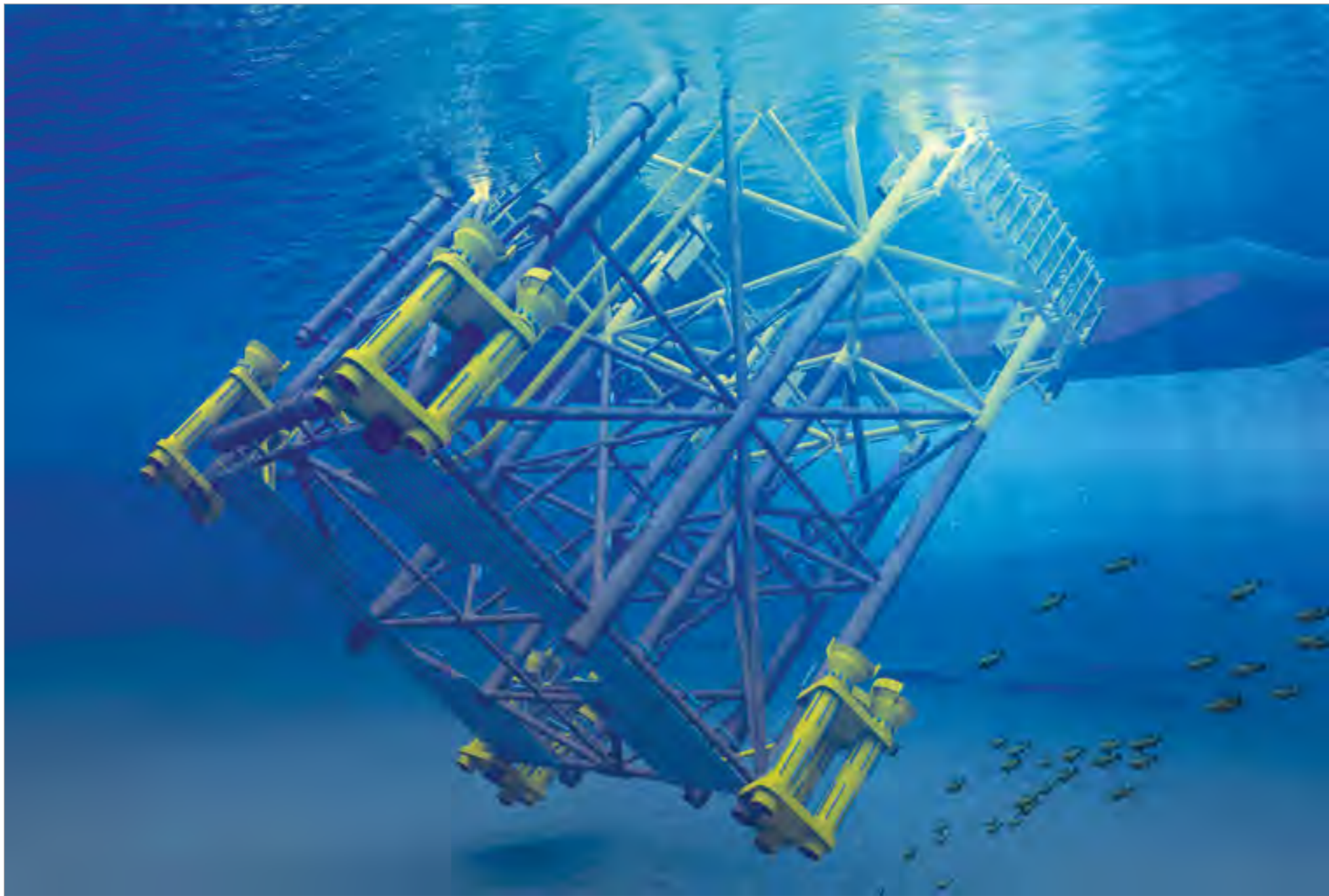

Your Next 3D Animation Project Will Be A Success

If your company is looking to create a professional 3D animation International Energy Club is the perfect partner. With 13 years of experience, and reference letters from so many well know inter-national companies, you know that your next 3D animation project will be a success.

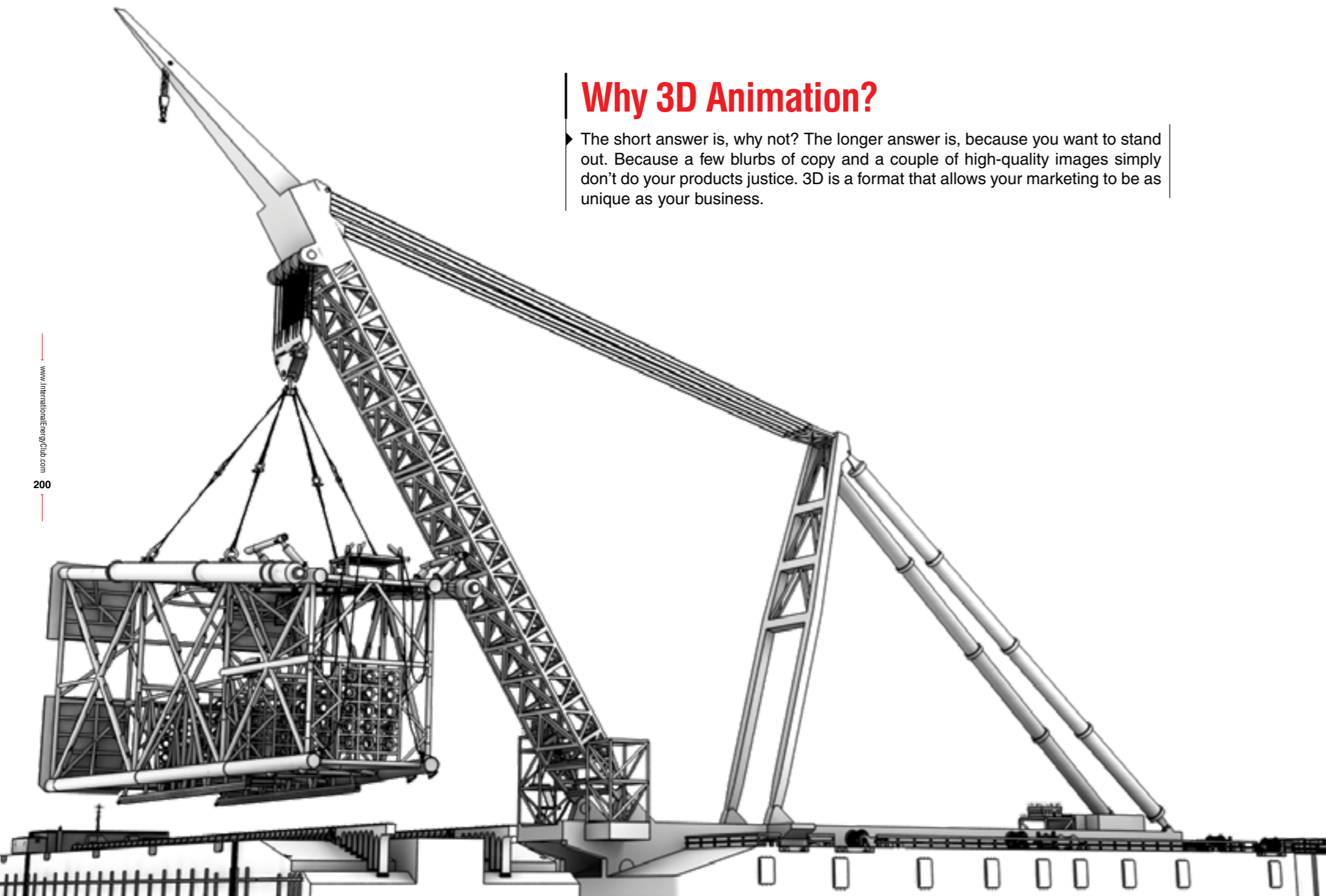

Why 3D Animation?

► The short answer is, why not? The longer answer is, because you want to stand out. Because a few blurbs of copy and a couple of high-quality images simply don't do your products justice. 3D is a format that allows your marketing to be as unique as your business.

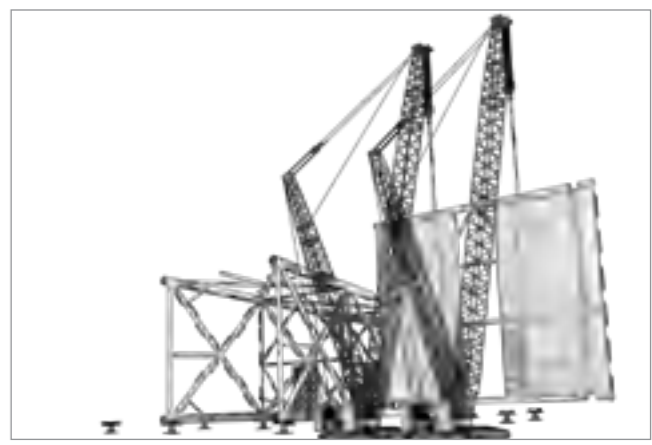
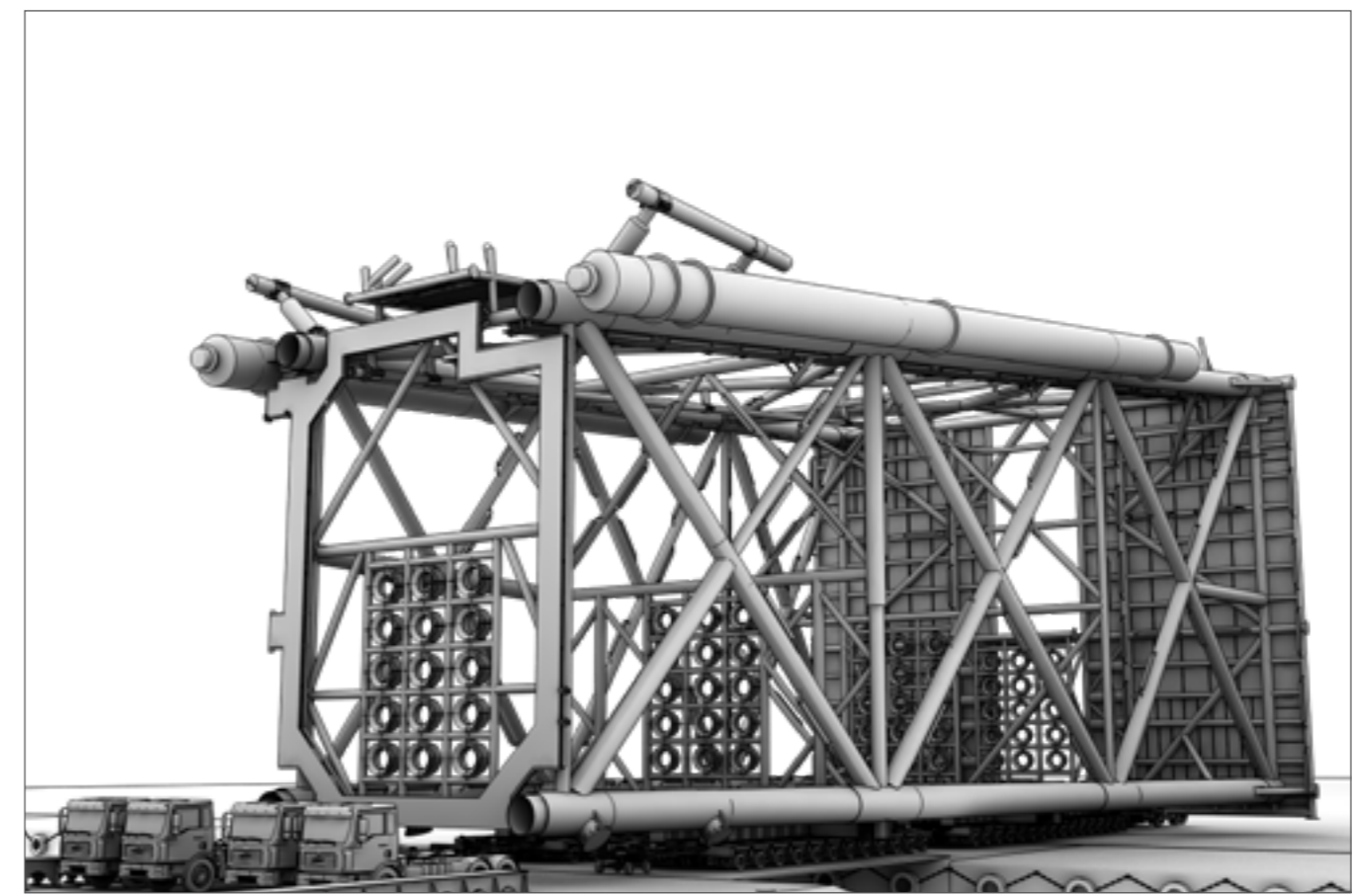

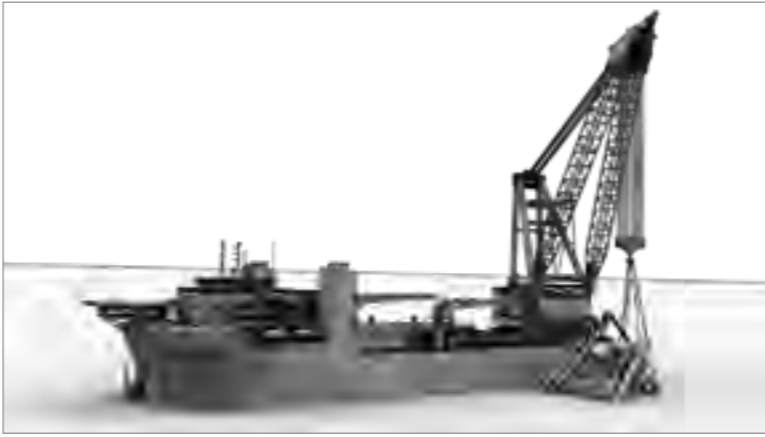

How 3D Animation Benefits Your Business?

► Animation nowadays has proven itself as the leading marketing and advertising tool which acts as a mass communication medium. Animation has many privileged characteristics that no other marketing method can match. The 3D animation services consist of many different features suitable for various requirements. 3D animation has so many varieties and usages that it has something for every industry.

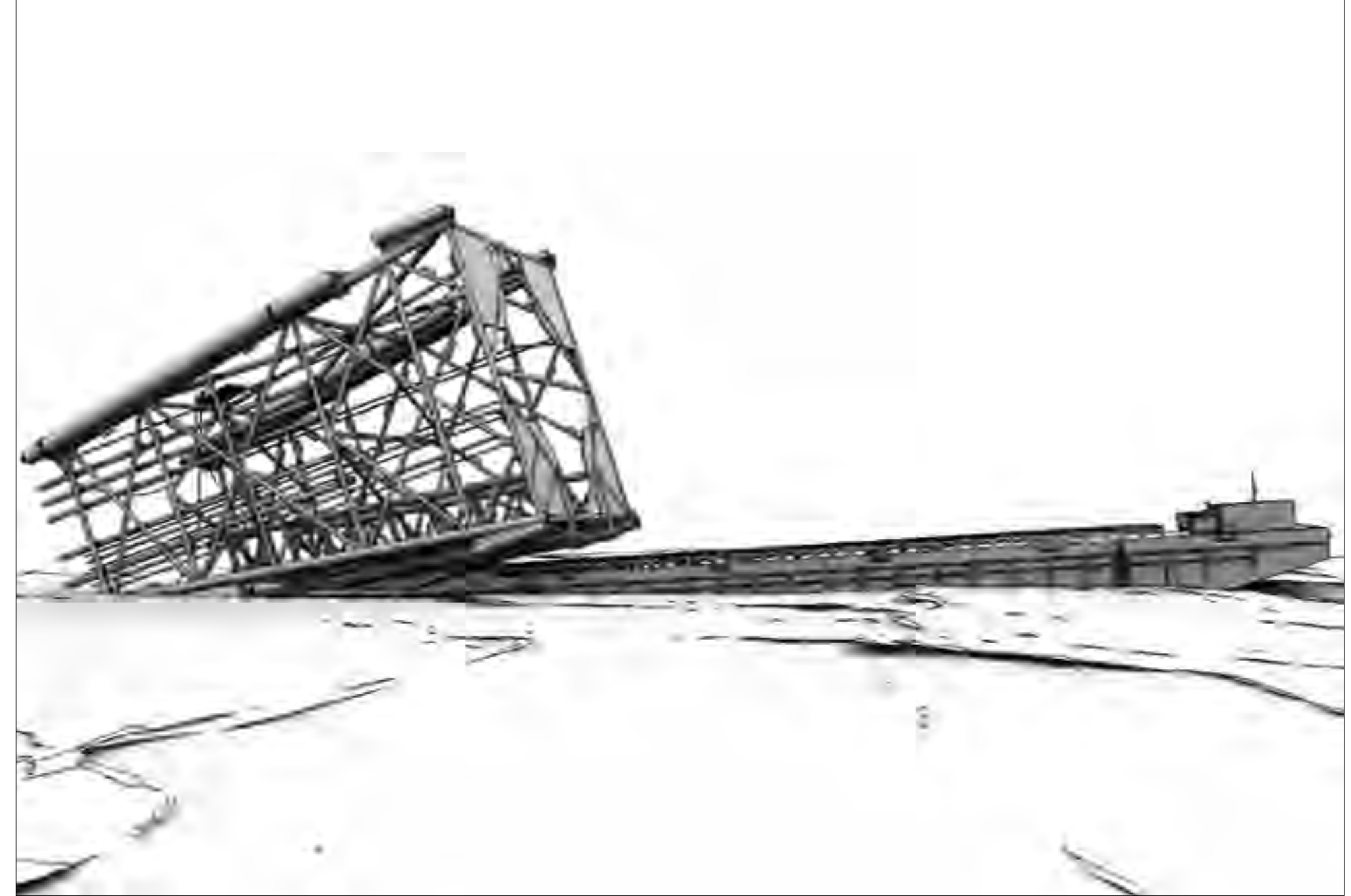



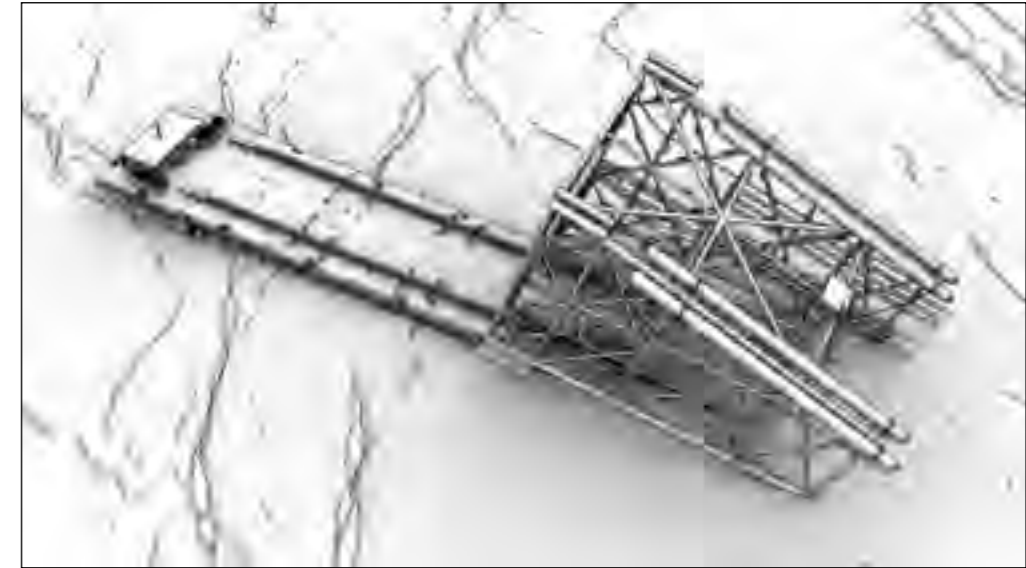





Present, Teach, learn & Sell, In 3D!

It's not enough to simply possess superior technology and creative talent. At International Energy Club, we go further by demonstrating our proficiency in blending a mastery of 3D design, modeling, compositing, and animation with our extensive oil and gas industry knowledge and help you to present, teach, learn and sell in 3D. We feature the industry's Best staff of 3D animators, as well as a comprehensive library of oil and gas industry videos and graphics.

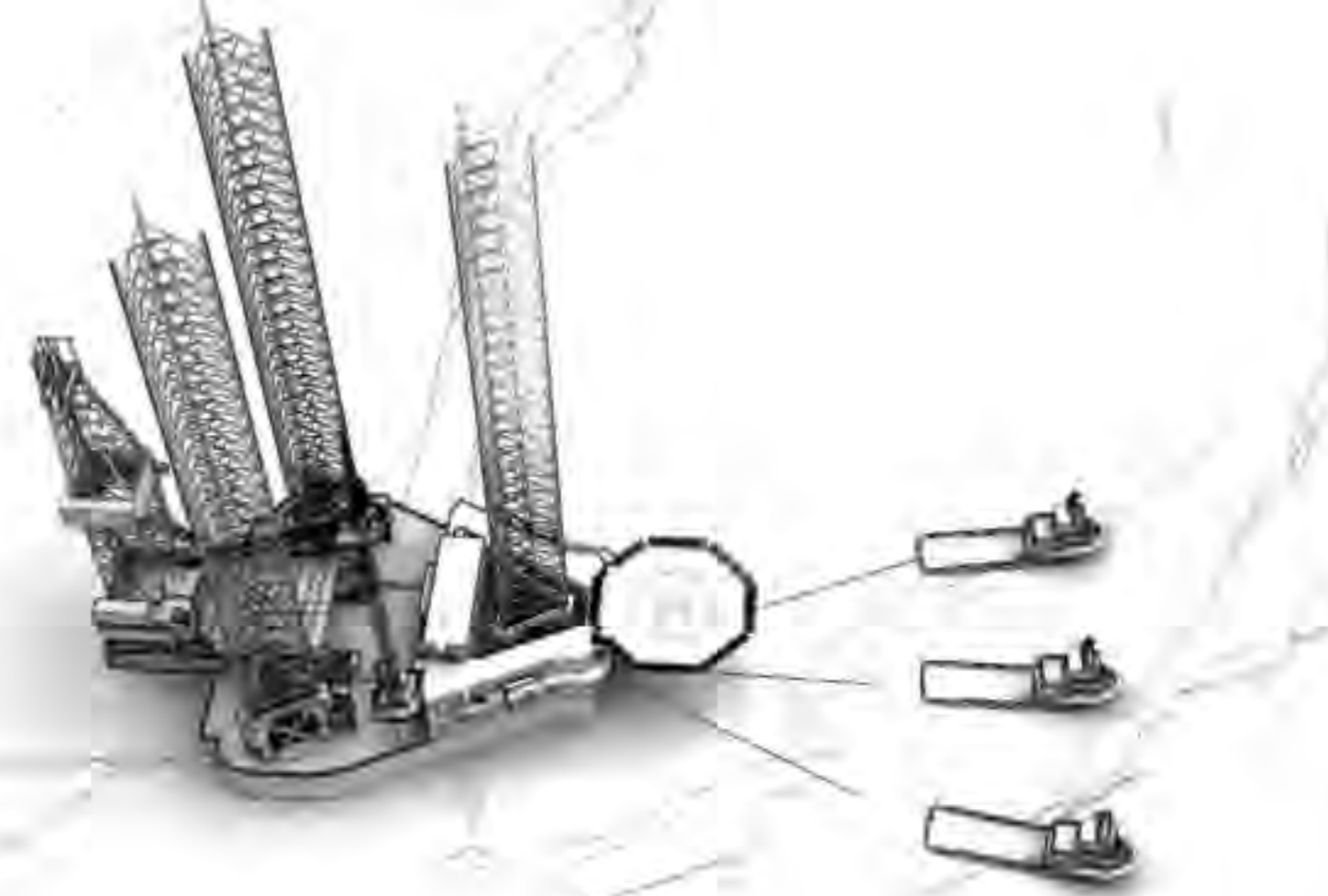



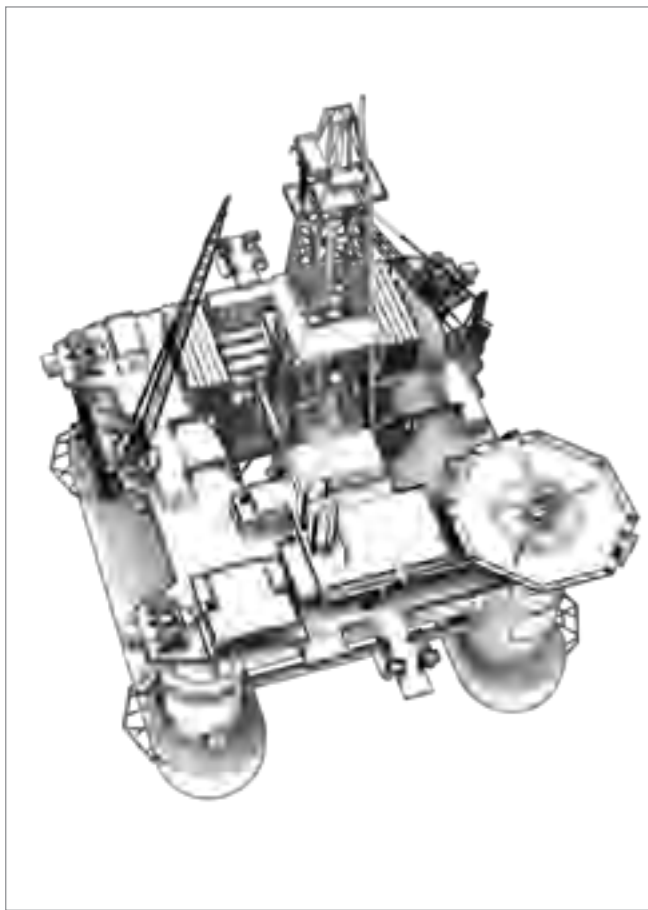





Simplify Your Communication With Your Audience

▶ 3D animation services simplify communication between you and your audience, and 3D modeling offers the realism of photography with far greater efficiency and flexibility. Visualize your project in a way no traditional media can and take advantage of the benefits of 3D models. International Energy Club has a long history of producing all types of 3D designs for any product, service or purpose in the oil & gas industry you can think of. Using 3D visualization techniques, you can control lighting, camera angles, textures, and colors with ease.





The interworking of equipment and process lines which cannot easily be represented in words or even through illustrations can be easily created and viewed from different angles in 3D animations.







Interact With Clients Through Animation

▶ In past decades, your option was to leave a business card and some documents with a potential client. But we can custom draw and do the modeling of the equipment, your company has patented, so there is no loss in translating the animation to reality. Although everything we do, begins with a hand drawing or basic digital design, but the final oil, gas animations, will offer a dynamic illustration of your larger vision.



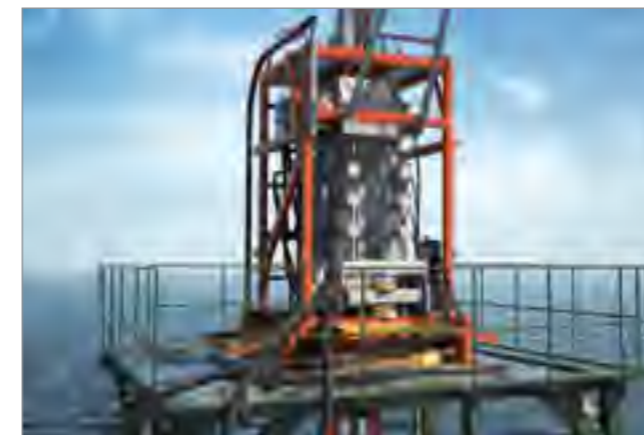

Tell Your Story like It's Never Been Told Before

▶ You have only one shot to tell your story. Oftentimes, you have a tremendous amount at stake and need every competitive edge. Put us on your team. When you enlist our unmatched experience and expertise, you already separate yourself from your competition. Your communications project starts from a position of strength - and that is only the beginning. With our advanced visual communication techniques, tell your story like it's never been told before.



A Well-Made Animation Will Stick To Their Minds

▶ High-quality 3D Animation is great for promotion. Using the technology and imagery, firms could explain the goal of their business very well. A well-made video animation will stick to their minds for a long time and will make a remarkable brand. Thus, it will create individuality and amplify unique-ness.



3D animation or Virtual Reality can be used to simulate dangerous scenarios in the oil and gas industry. For example, the fire on an offshore oil rig can be shown, along with the procedures for extinguishing the fire, and the best methods for preventing injury to staff and firefighters.





We Help You To Captivate Your Audience

The Special FX capabilities of animation - such as being able to create realistic liquids, fire, light, extreme heat or cold for example - makes it a very powerful tool. Space, time and the laws of nature can be molded to suit your purpose. Visual effects can be used with your animation to enliven any idea or to create a 'WOW FACTOR' that demands the audience's attention.



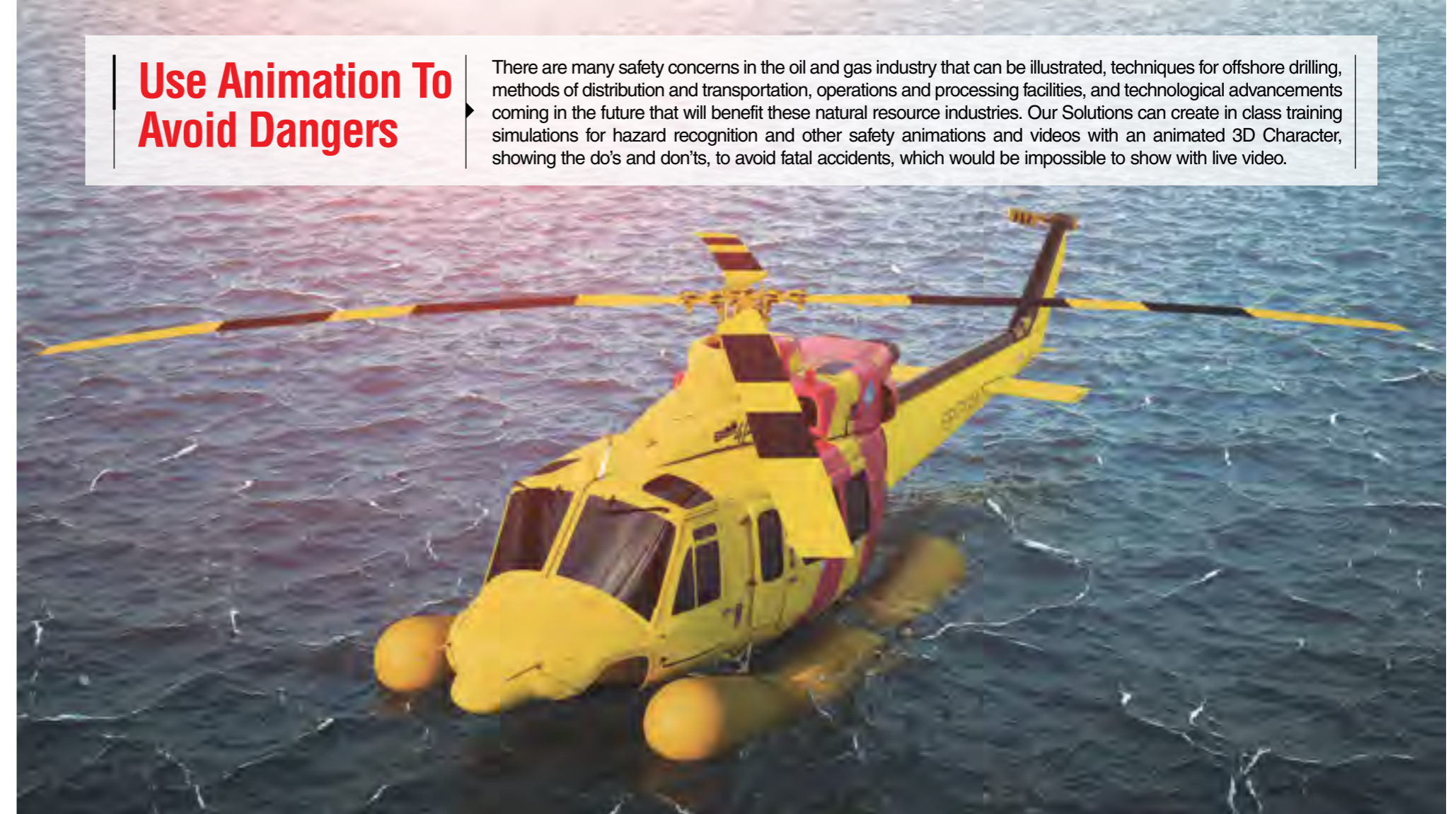

Use Animation To Avoid Dangers

There are many safety concerns in the oil and gas industry that can be illustrated, techniques for offshore drilling, methods of distribution and transportation, operations and processing facilities, and technological advancements coming in the future that will benefit these natural resource industries. Our Solutions can create in class training simulations for hazard recognition and other safety animations and videos with an animated 3D Character, showing the do's and don'ts, to avoid fatal accidents, which would be impossible to show with live video.



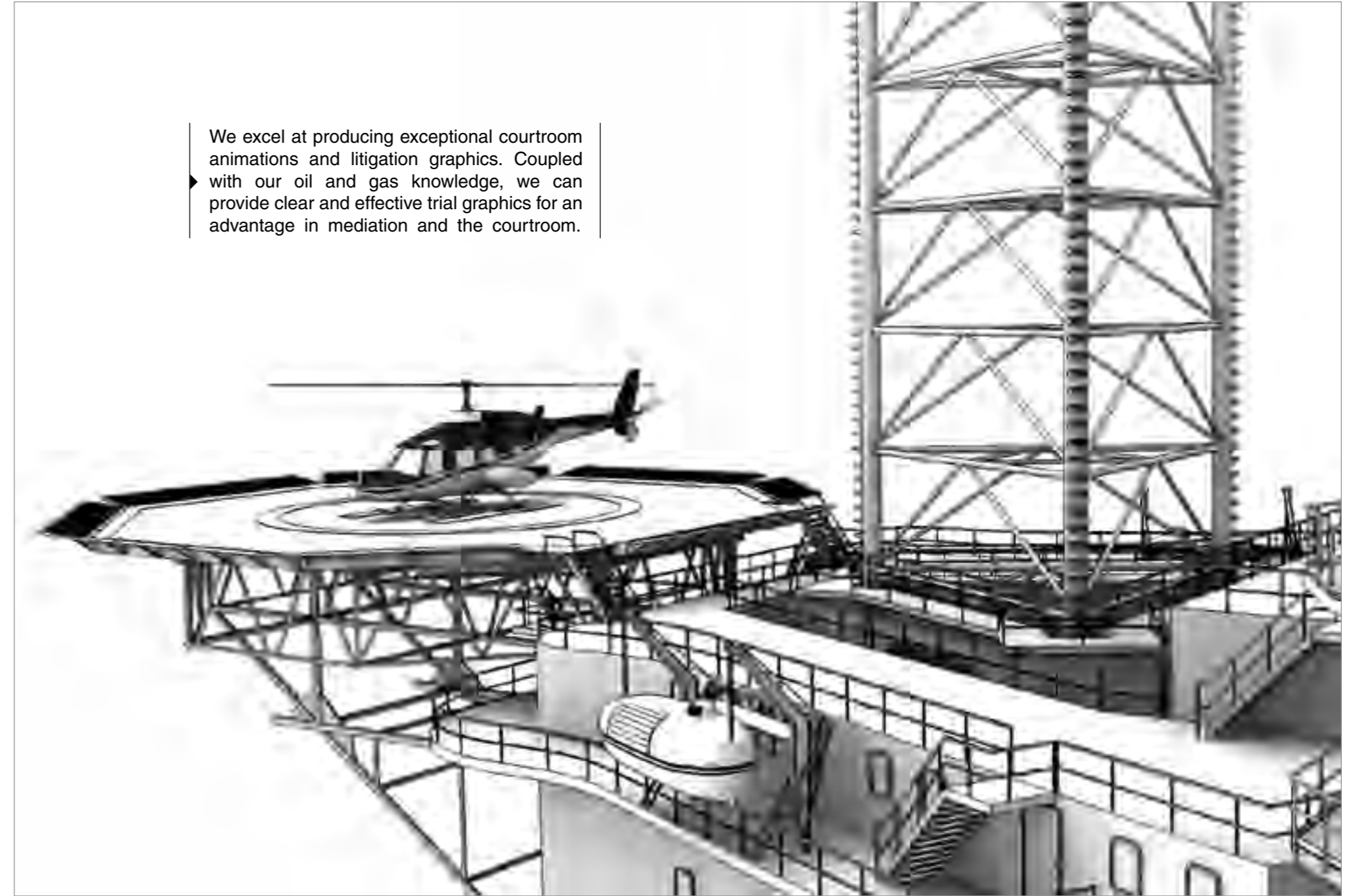

We excel at producing exceptional courtroom animations and litigation graphics. Coupled with our oil and gas knowledge, we can provide clear and effective trial graphics for an advantage in mediation and the courtroom.

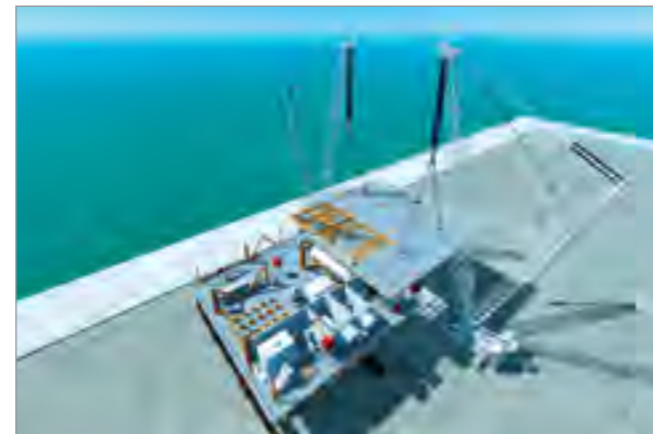
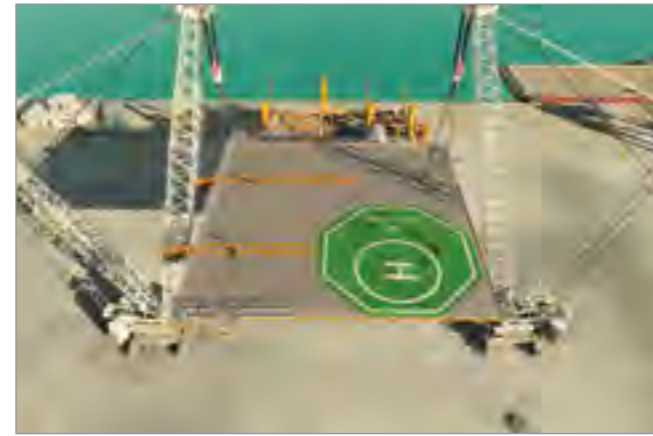



Animate Your Products – Move Your Sales

90% of customers say video helps
them make buying decisions.
-Forbes

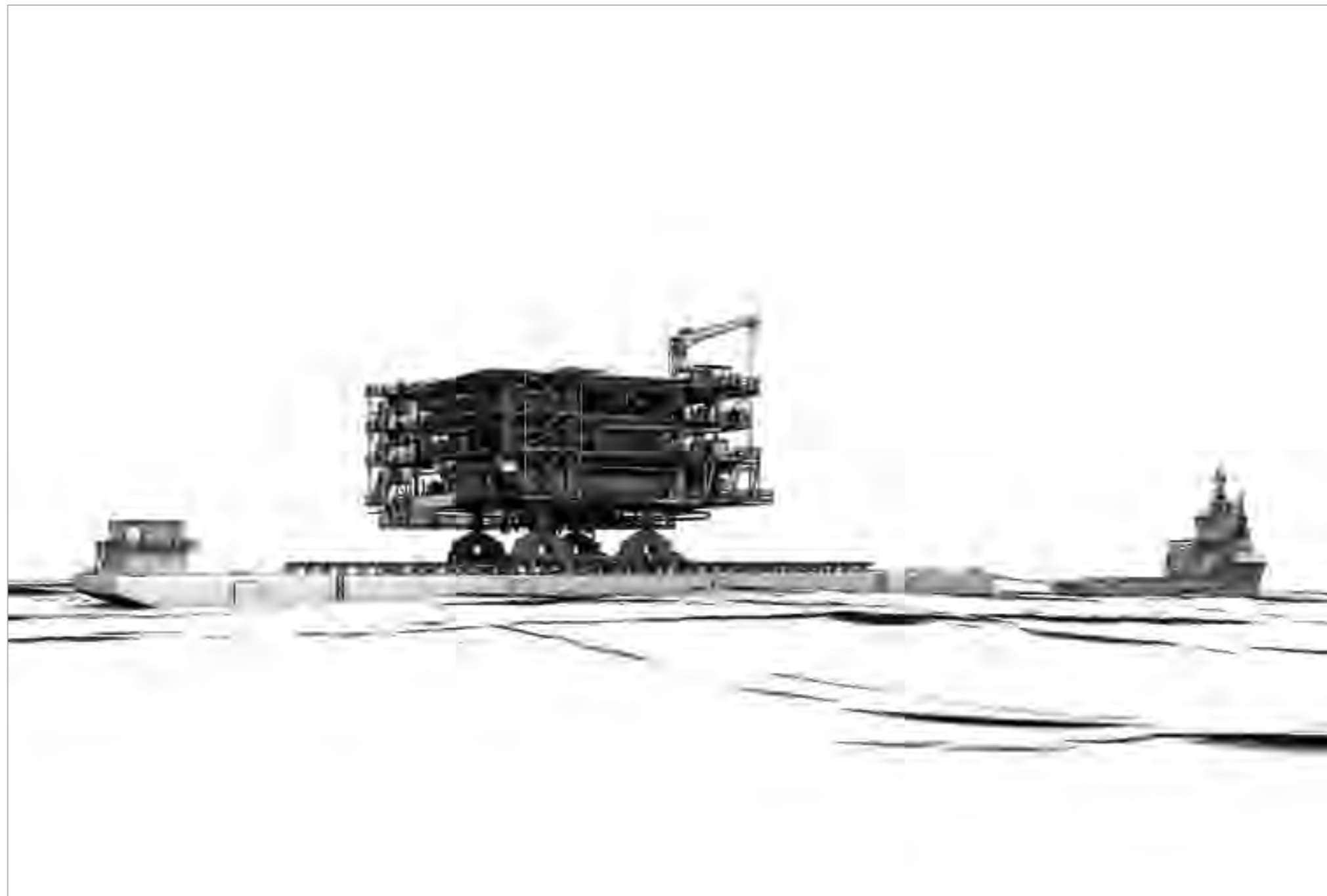



We Know How To Work With Experienced Engineers

International Energy Club is already familiar with most of the terms and procedures used in the offshore and marine industry, we have modeled many types of existing vessels, and have firsthand knowledge of working with experienced engineers in international companies. In fact, our background in offshore oil and gas and marine industry, has given us a ton of knowledge and a special mindset that we apply to our projects. As our work samples show, we have all the technical and artistic know how required to deliver the highest quality.

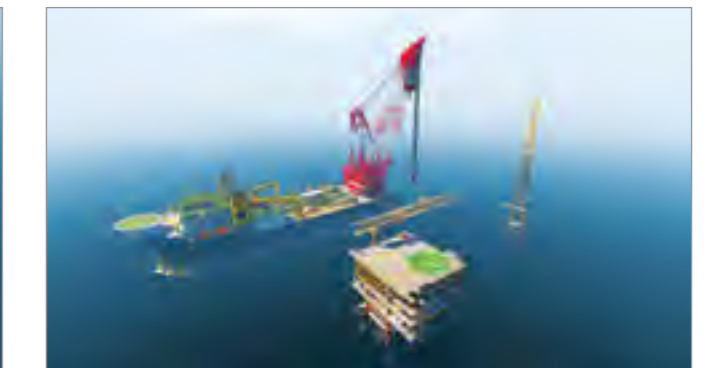

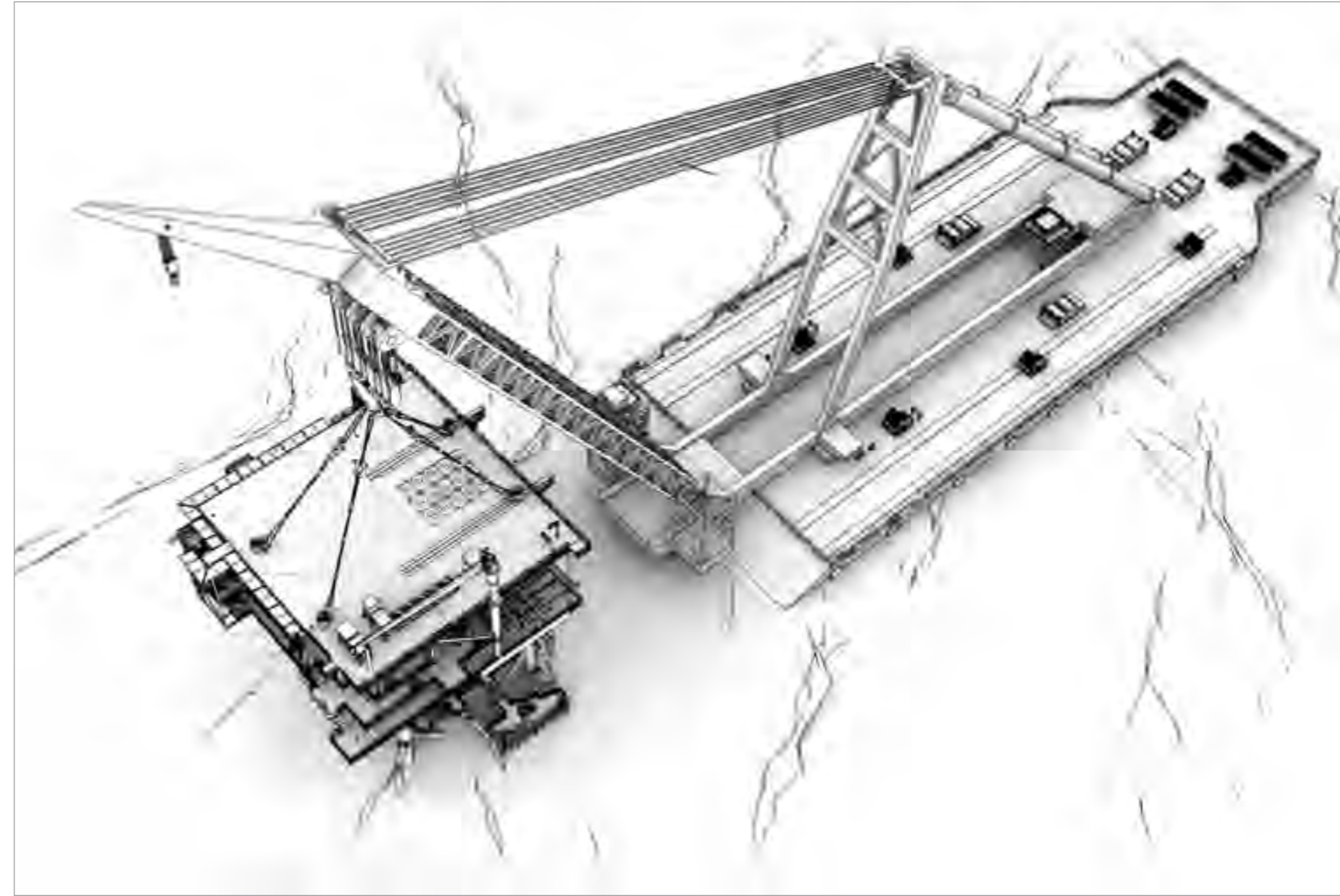



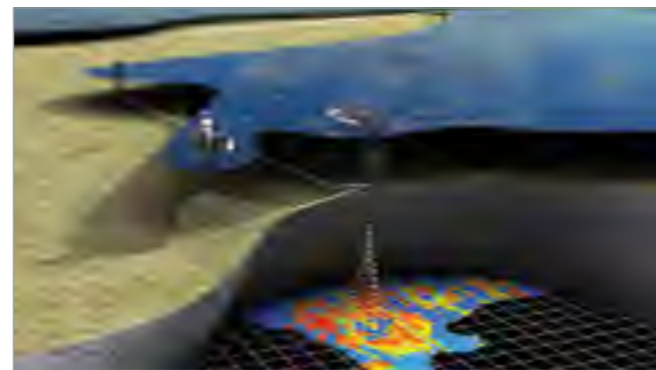
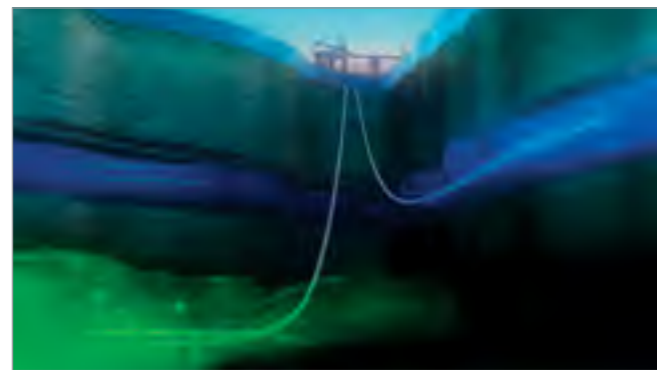
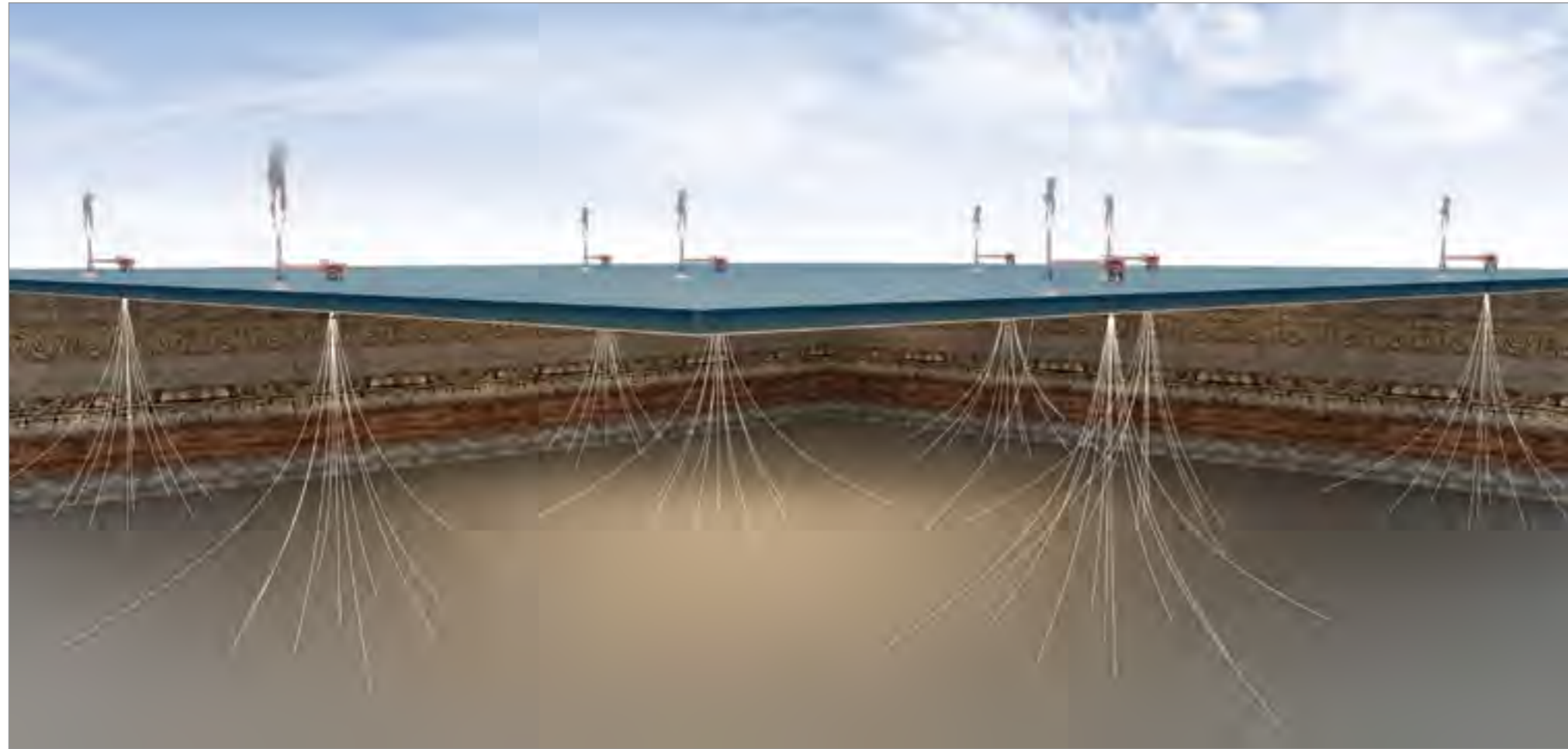

Animation Helps To Have A Better Planning For Exploration & Production

► Being able to convert technical data and geological information to a 3D model and show it on a screen in a virtual environment gives the oil and gas geologist and engineering staff the opportunity to see oil and gas reserves thousands of meters underground or under water in a realistic depiction. This gives geologists and engineers a better view of the oil reserve so they can better plan for their next exploration drilling program.





You Can Trust Us

We do not outsource any aspect of your project including the computing power to render the images. International Energy Club Systems are continually expanding upon its own render farm, allowing us to take on more projects and complete them quicker than any group or independent consultant could.

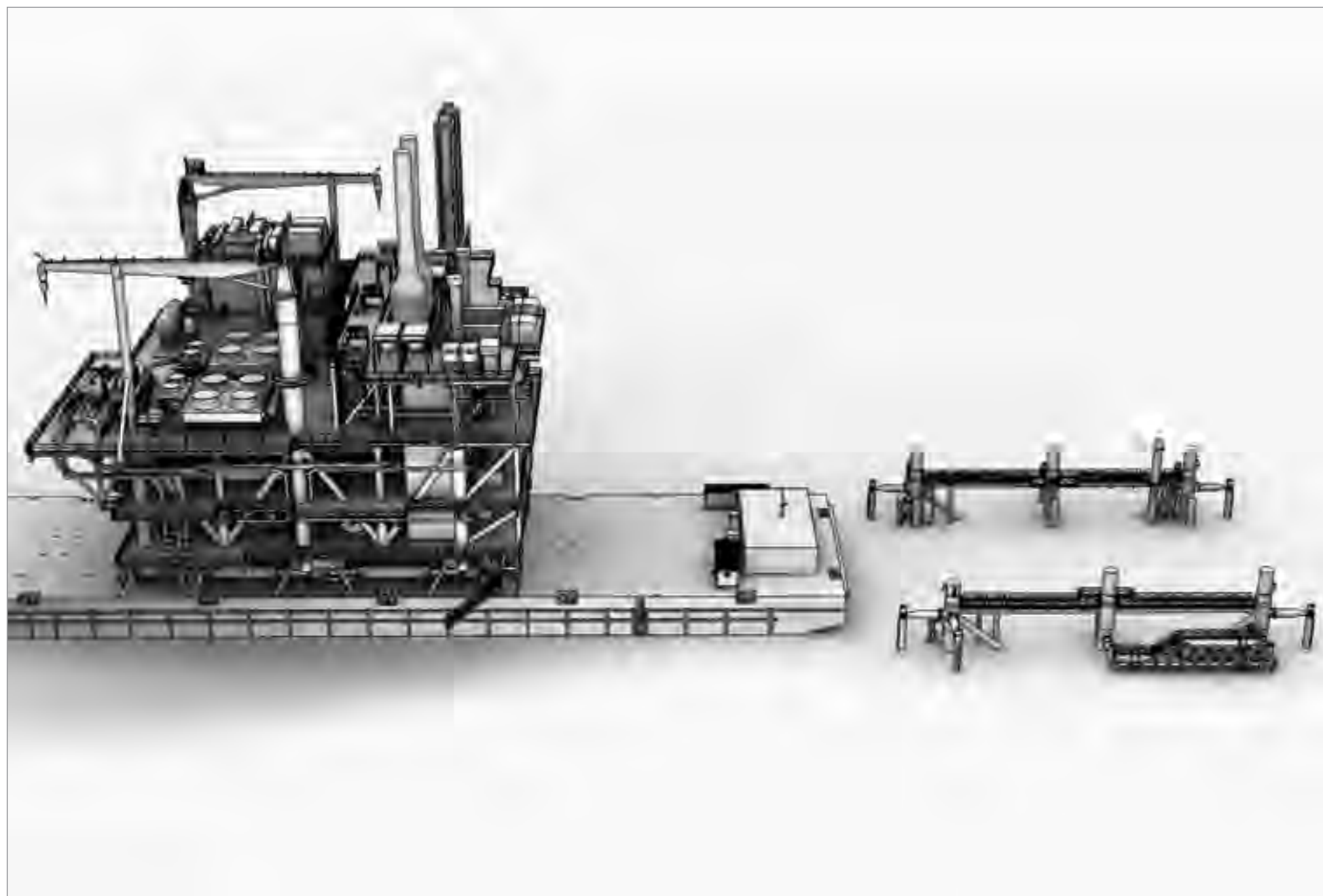



You Can Control Your Project

Every one of our clients has access to our account management, project management, and creative teams at all times throughout the duration of their projects. Since we are relatively small in size, all of our team members work closely with one another on a daily basis to ensure everything runs like a well-oiled machine. Our goal is to provide our clients with a level of comfort to where they can come to us at any time with anything that may be on their mind. We sure at the end of your project, you see us as a member of your team, instead of an outside animation studio.

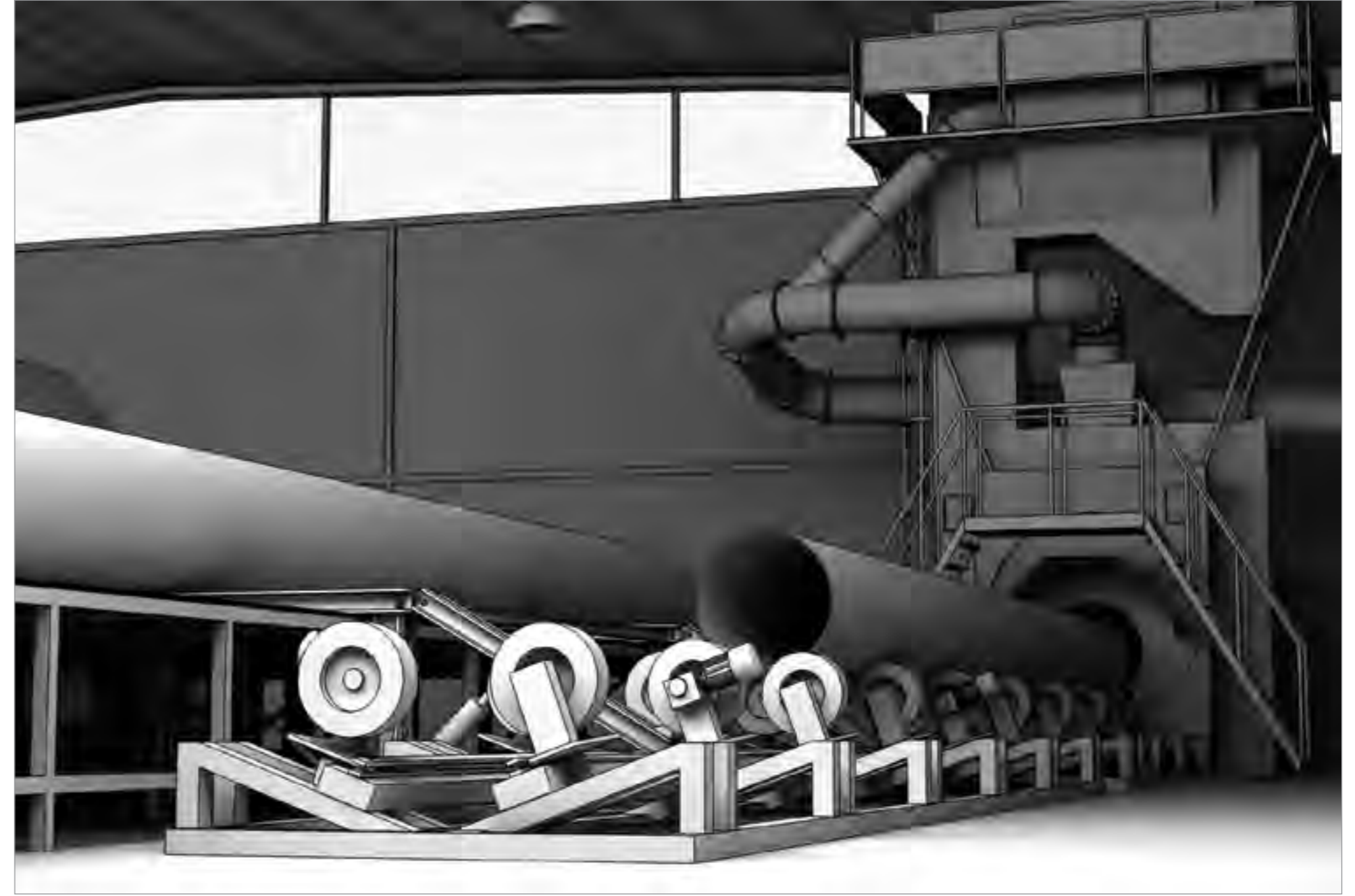
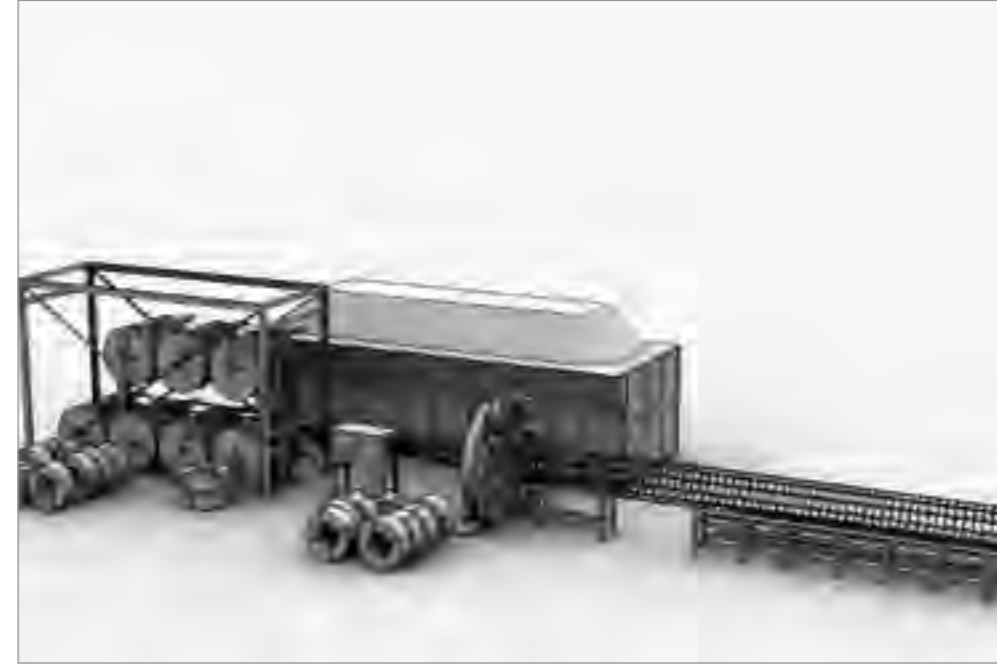
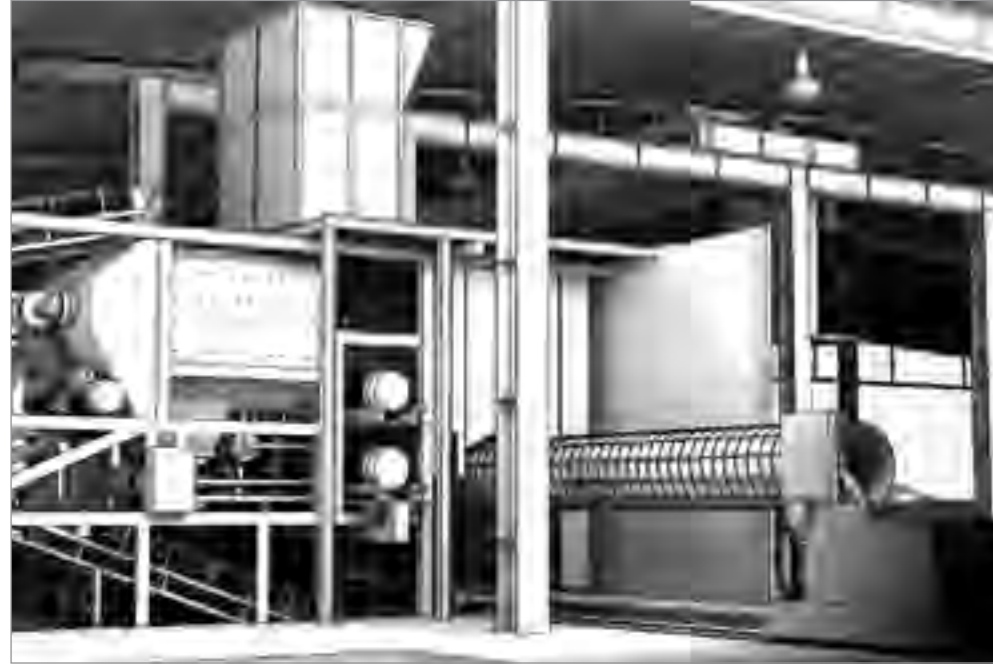



How Do We Start?

► We start with getting to know your company. We consider ourselves an extension of your team, and offer the same level of dedication as a full-time employee. Once we understand your brand and goals of the project, we can get to work on your animation featuring oil drilling, exploration, offshore operations or any other custom concept that could utilize oil and gas animation to bring it to life. Your approval is always requested in the storyboard stage, and we give you the chance to review the visuals before animation is applied.



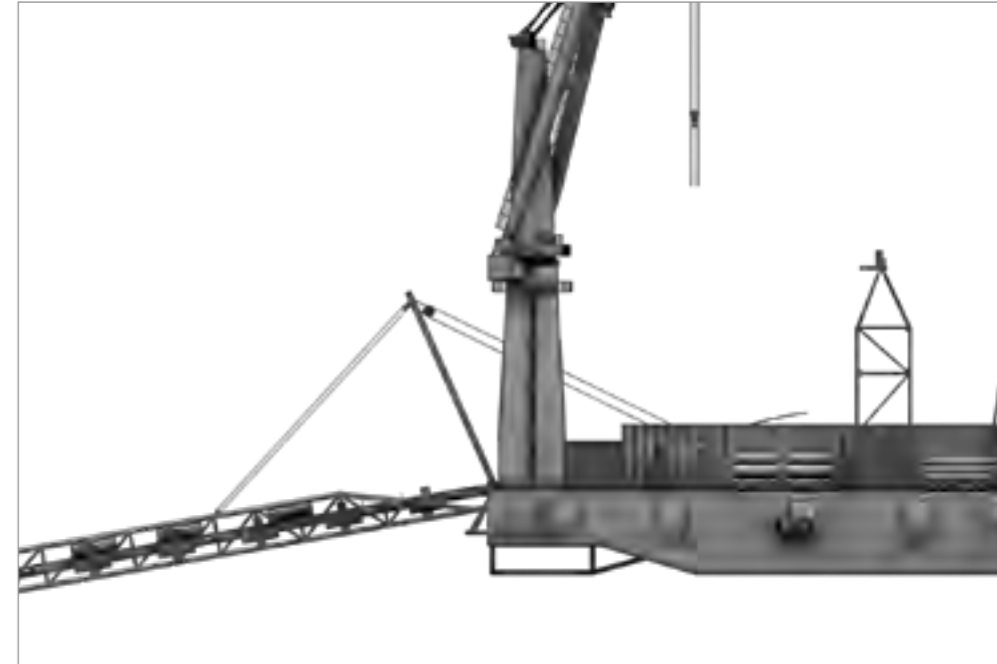
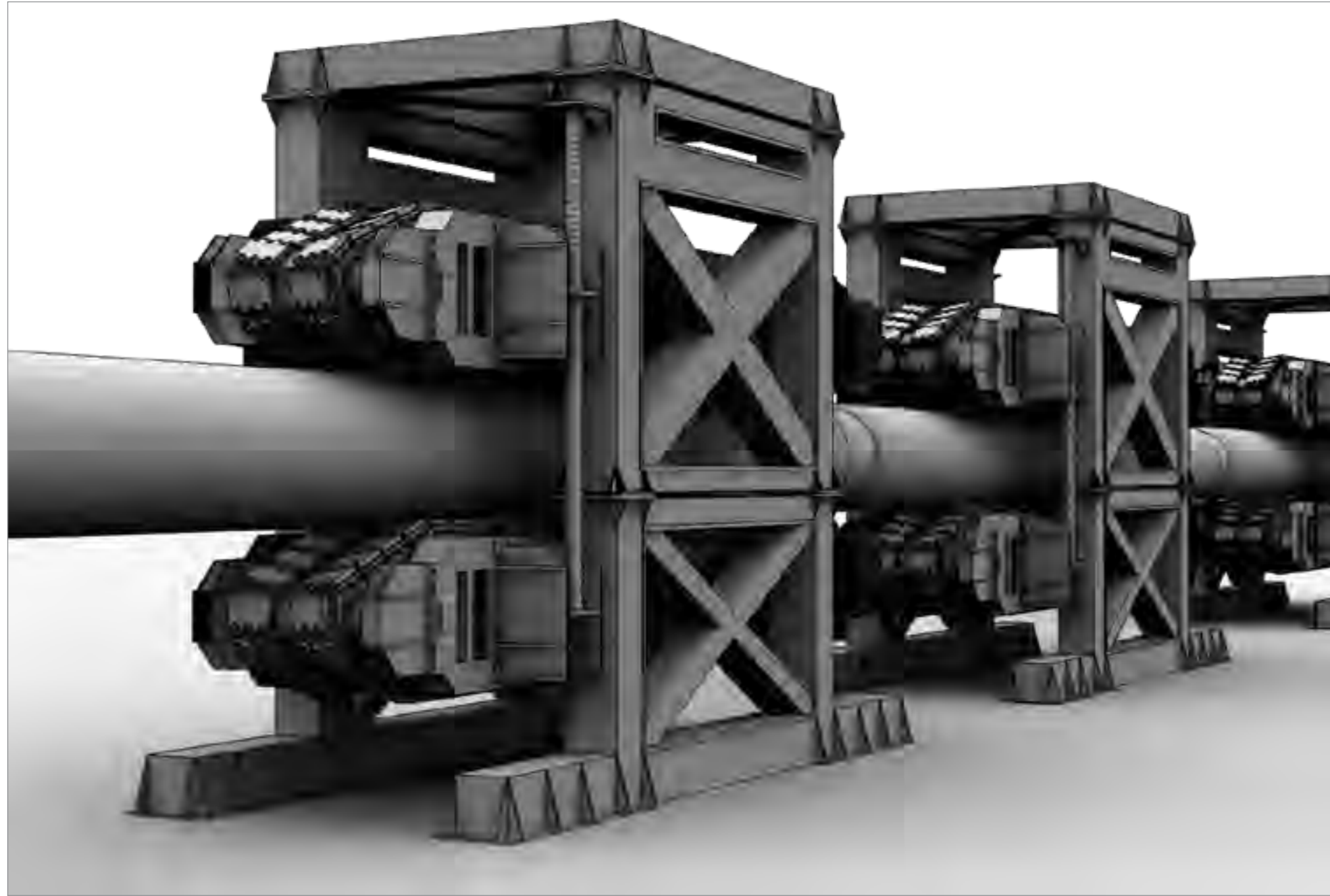

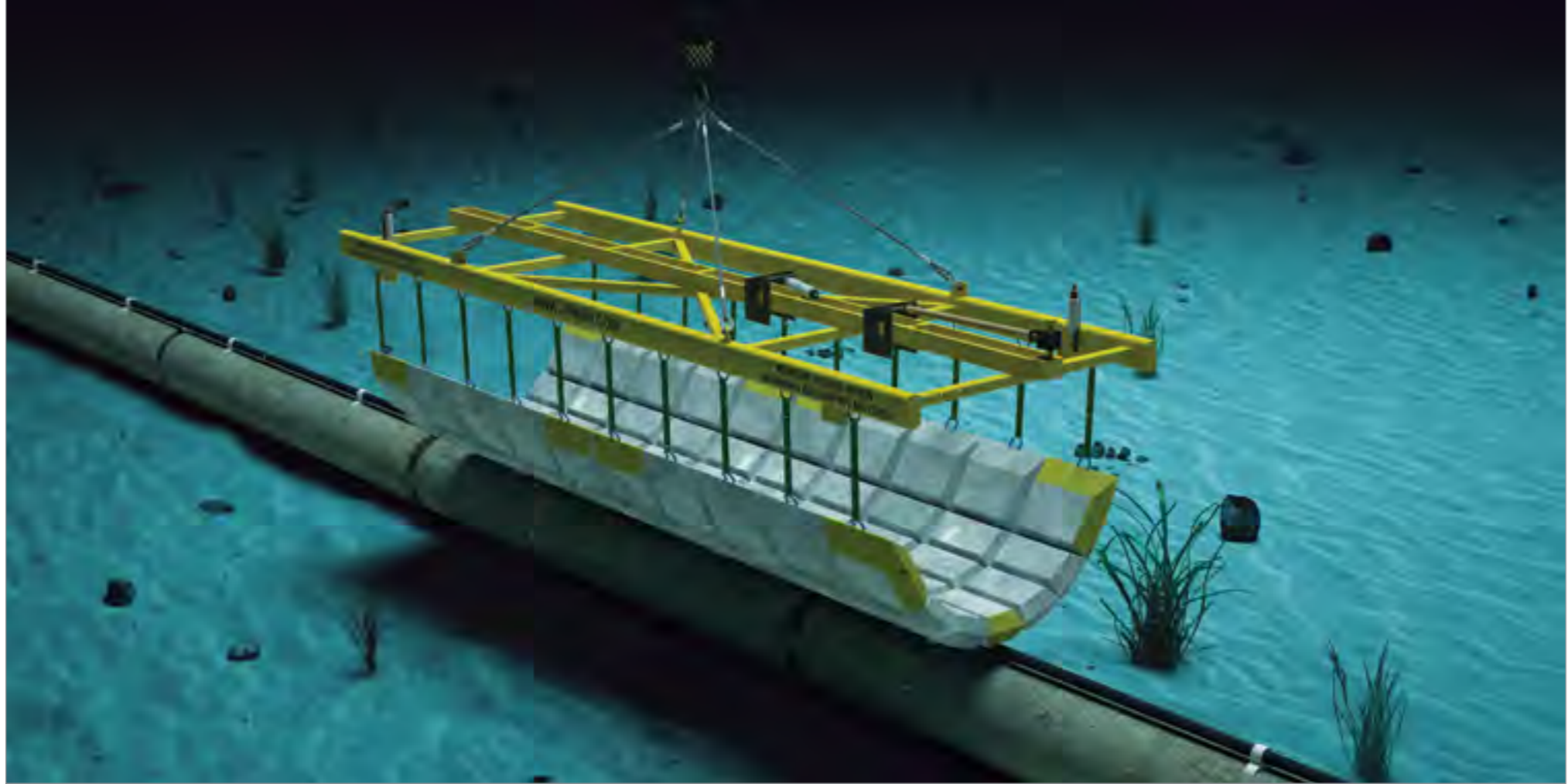

Are You Ready For Success?

▶ To be brutally honest, we're damn good at trade show animations. Serious trade show media can't be handled by the guy in your office who has dabbled with After Effects, or the website vendor you really like who also recently started offering video services. This is serious business, and you need serious minds on your team. We do video. Are you ready for success?

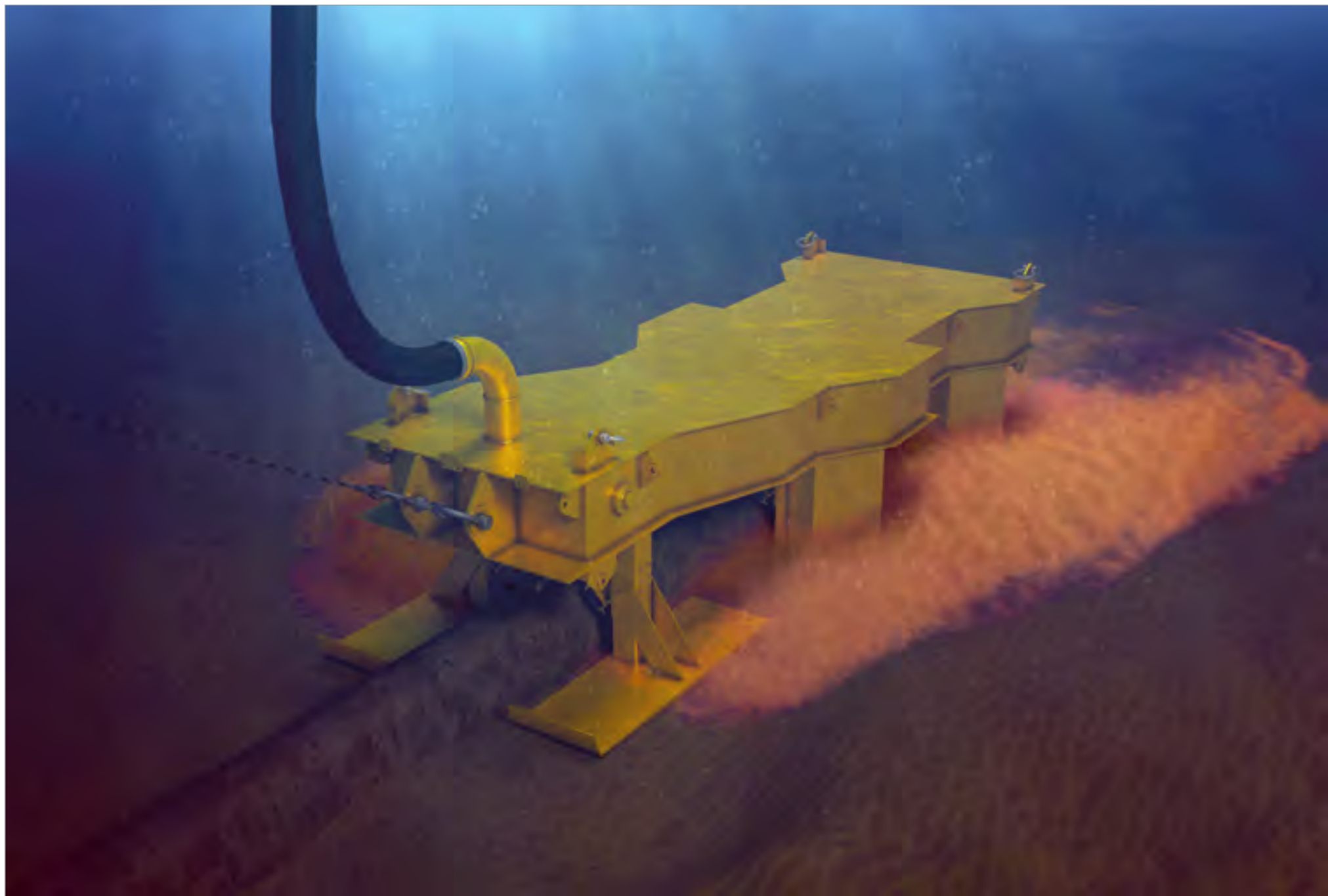
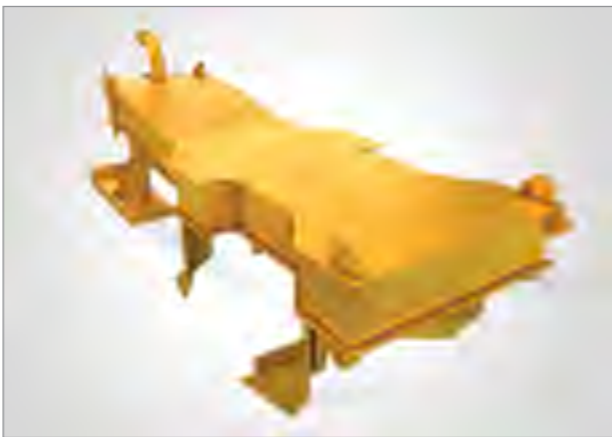



Where Exceptional Talent & Technology Meet

▶ International Energy Club is a full-service 3D animation studio that provides any and all of your animation needs in the energy industries, including offshore oil & gas, marine and renewables energies Our design process is tailored to fit your needs, from ideation and storyboarding to the production of your final products. Over the years, we have accomplished the most sophisticated projects with great ease and quality. It is our promise to you that we will not stop working on your project until you are satisfied.

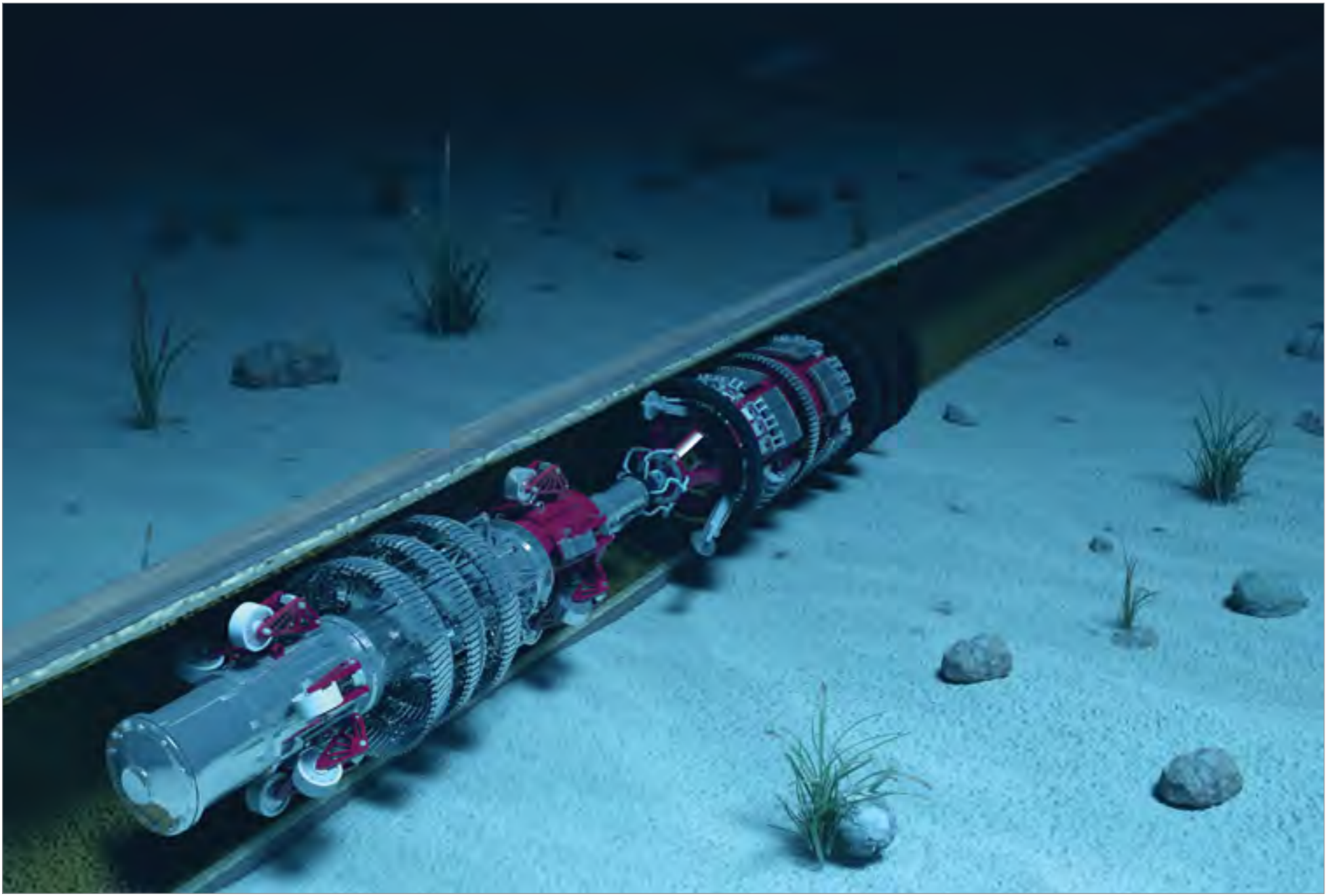



**We Are
Ingenious
Passionate
Enthusiastic
Hardworking
Dedicated
Disciplined
3D Artists**

Our Work Speaks For Itself

Everything we create is true to life, with the accuracy and detail you would expect from photography or video. Our clients are drawn from all design sectors and our still imagery or animations offer maximum impact.

We are best known for our work in creating technically-accurate, industrial 3D animations in the field of offshore, marine, subsea and renewable energies. In fact, attention to details, realism and accurate interpretation of designs puts IEC first with our clients.

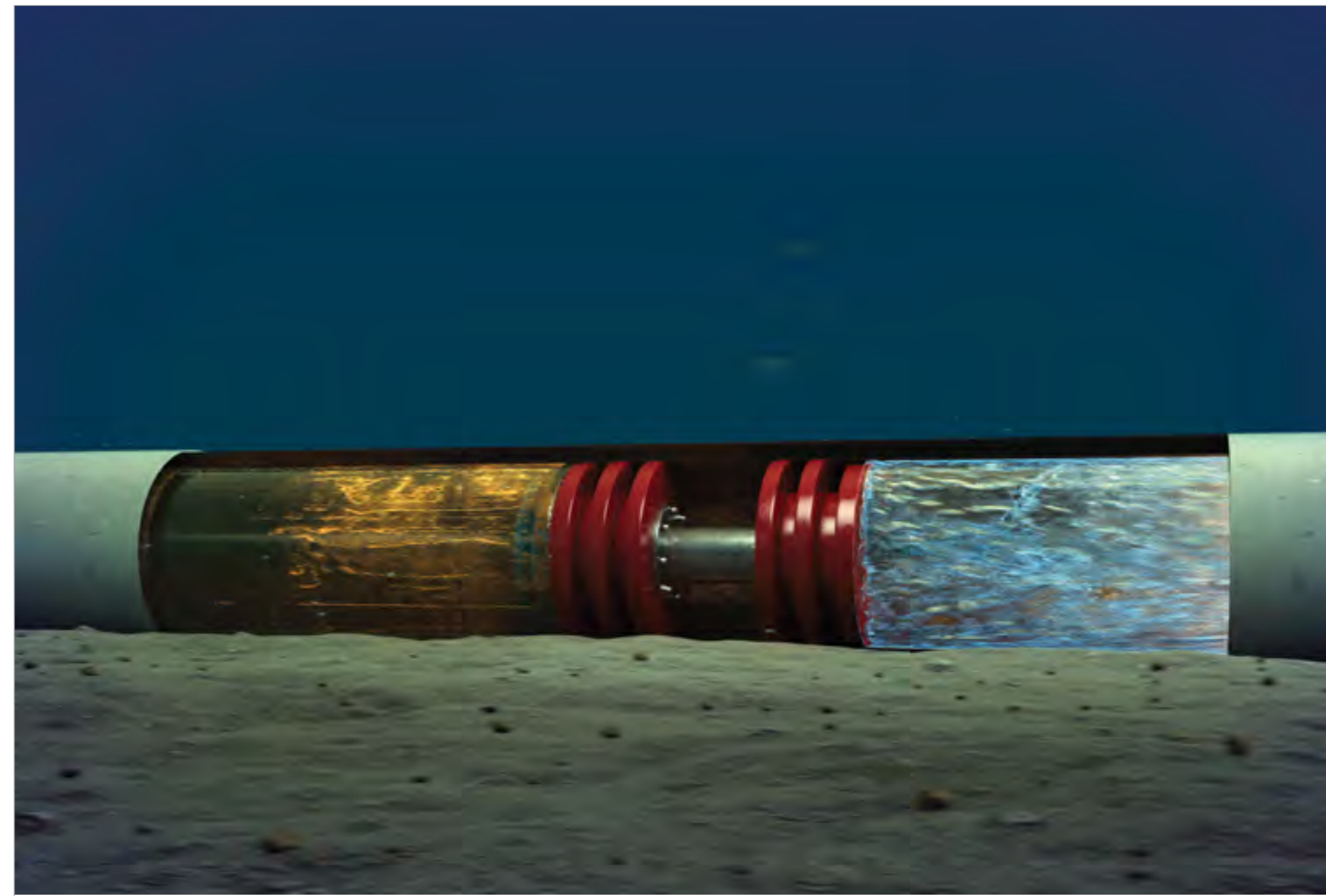

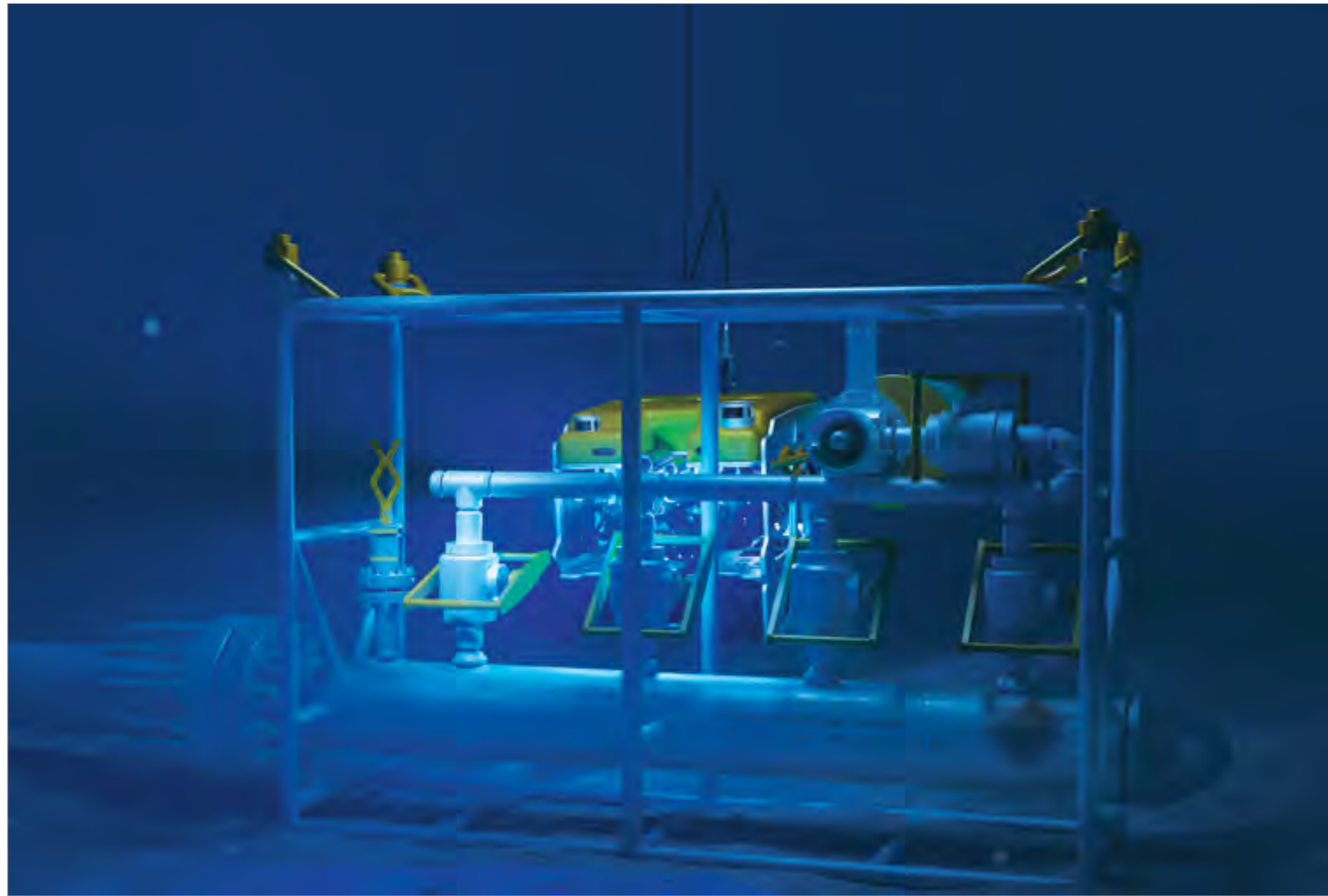





Animation is Future-Proof & Editable As Per Your Requirements

▶ This is a huge advantage of using 3D animation. The 3D models and other resources can be used later to modify the video to meet future requirements and updates. This makes sure the video is future-proof and editable as per your requirements. Just remember to be entertaining and engaging. But if you choose to do an animated video, you're halfway there. The rest of it is in knowing your audience and thinking outside the box to being creative and confident with your message so that you can communicate it in a unique way and connect with the people who will most likely appreciate it.







3D Animations For Inventors

International Energy Club can create animations and 3D illustrations for your invention to help you submit your ideas in support of your patent application. We can show you how your idea on paper would look like in real life, helping you improve your product or design before patent submission. Once you are ready to bring your idea to life International Energy club can help you create physical prototypes of your idea.







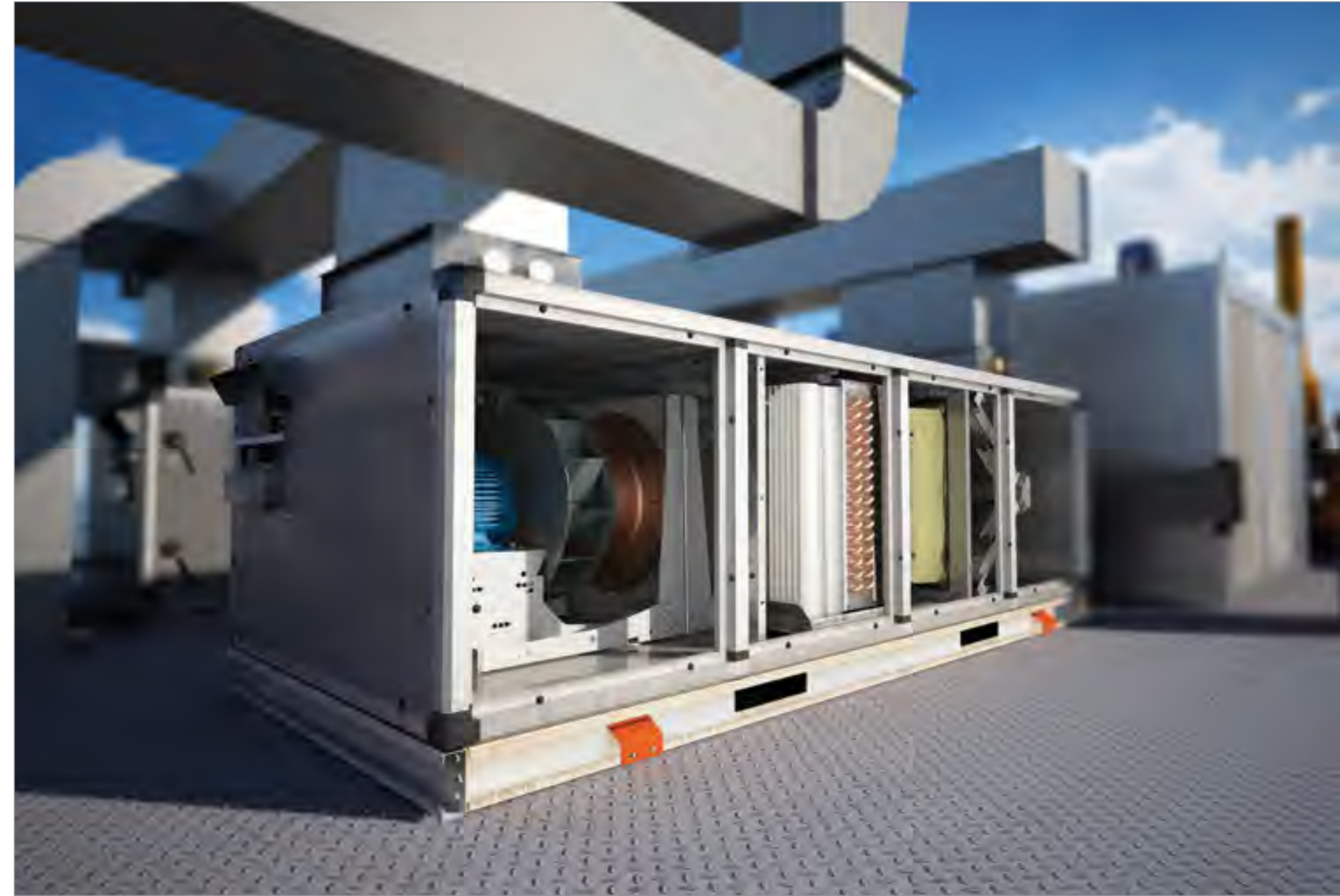

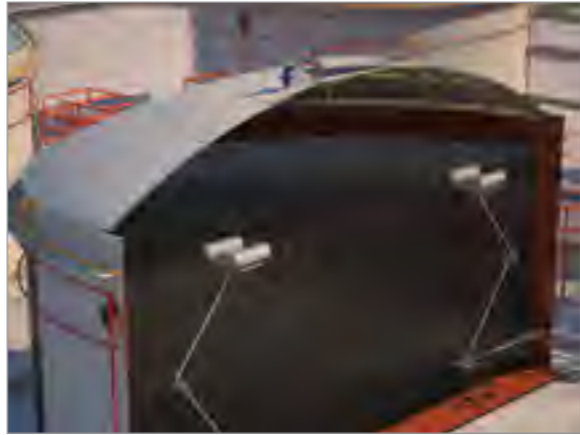
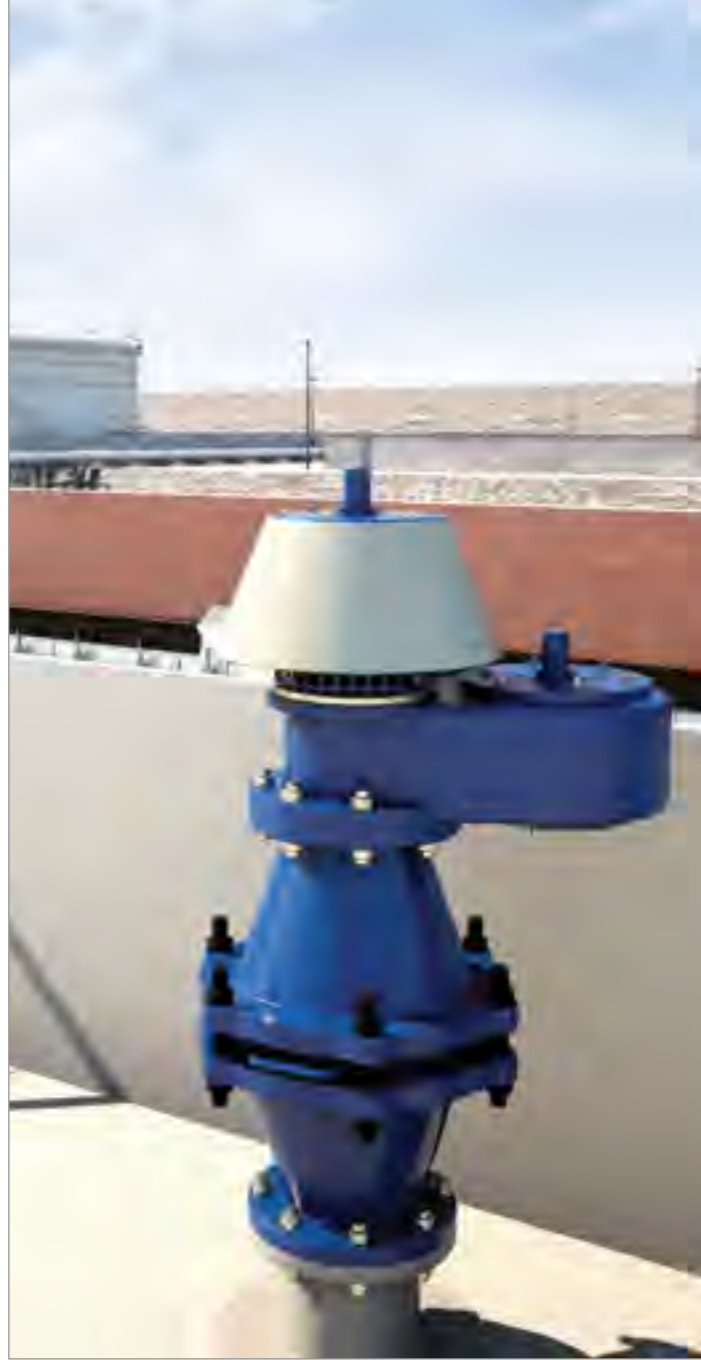

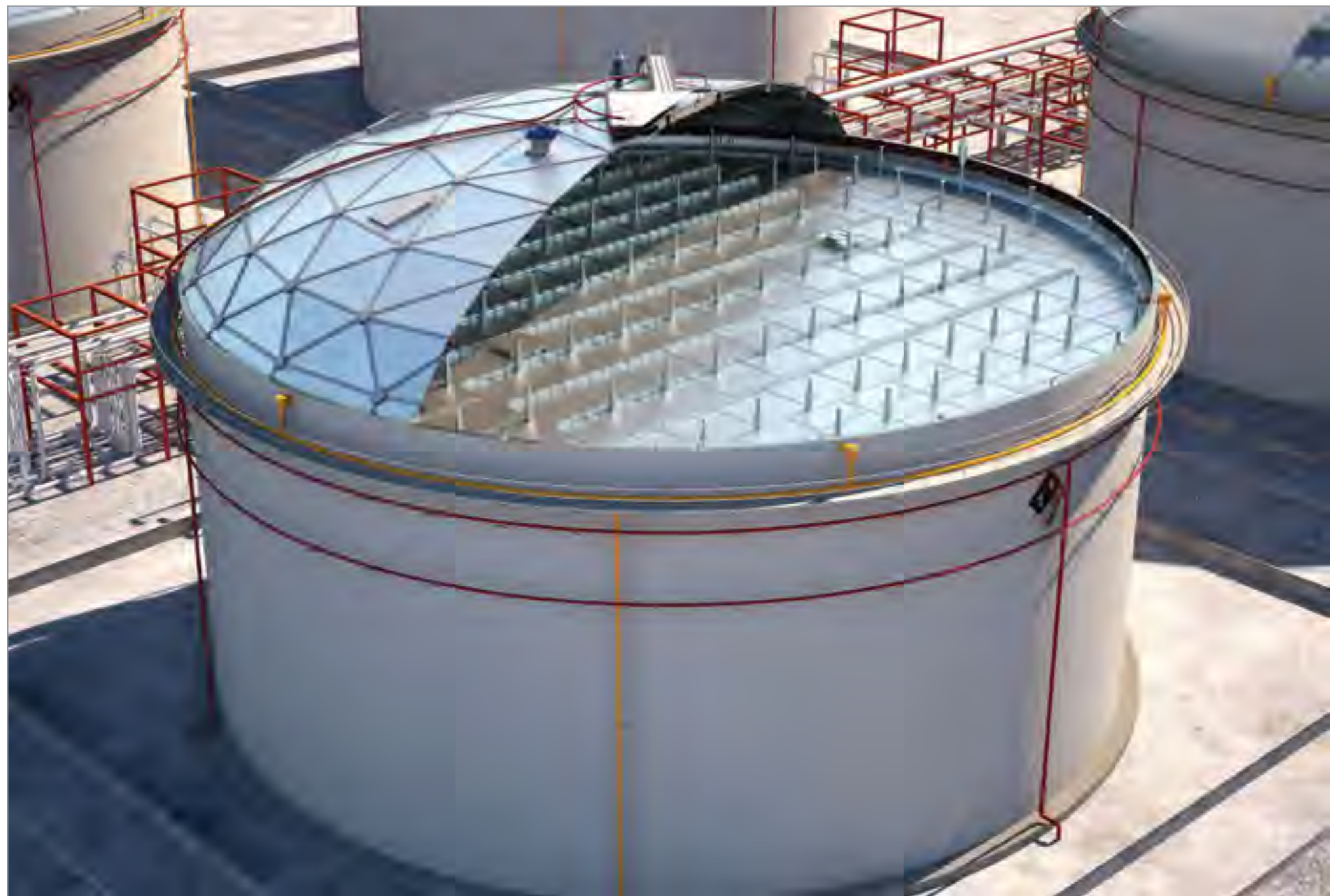

**If You Can Think It,
We Can Make It!**

International Energy Club is a full-service 3D animation studio that provides any and all of your animation needs in the energy industries, including offshore oil & gas, marine and renewables energies Our design process is tailored to fit your needs, from ideation and storyboarding to the production of your final products. Over the years, we have accomplished the most sophisticated projects with great ease and quality. It is our promise to you that we will not stop working on your project until you are satisfied.





Build Reputation Of Your Company By Animation!

Any organization can develop its growth and image through the use of 3D animation on a relevant subject. This is a great value addition to your company's market reputation. Be it Business marketing, sales, and presentations, Animation gives you the ability to make your products or services clearly explaining it to the customer making it more clear, precise and much easier to understand.

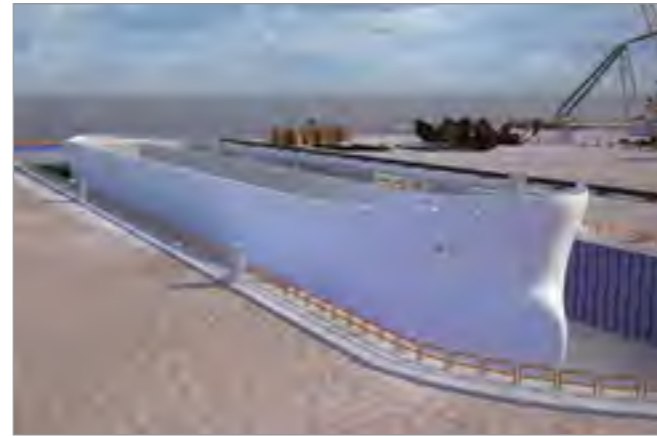



Enhance Your Brand With Help Of Latest Technology

Using 3D Animation as a marketing material for your company also increases your business reputation to a great extent. This gives the audiences a premium feel about your brand and also shows that you are always updated with the latest technology.













Catches Audience Attention

▶ many people would rather watch a product demonstration four times more than to read a description about it, this leaving no doubt about the benefits of making animation for your idea, product or project. This universal appeal creates a great impact, especially in promotion. Once you've got their interest, it is easier to introduce to them your products and services.

Availability Of Online Platforms

► Wide-spreading your 3D video on products or services to multiple online platforms is crucial in increasing the traffic. You may create a immense online presence in the most sophisticated manner. At the end of the day, this will bring you more leads and subsequently more business.

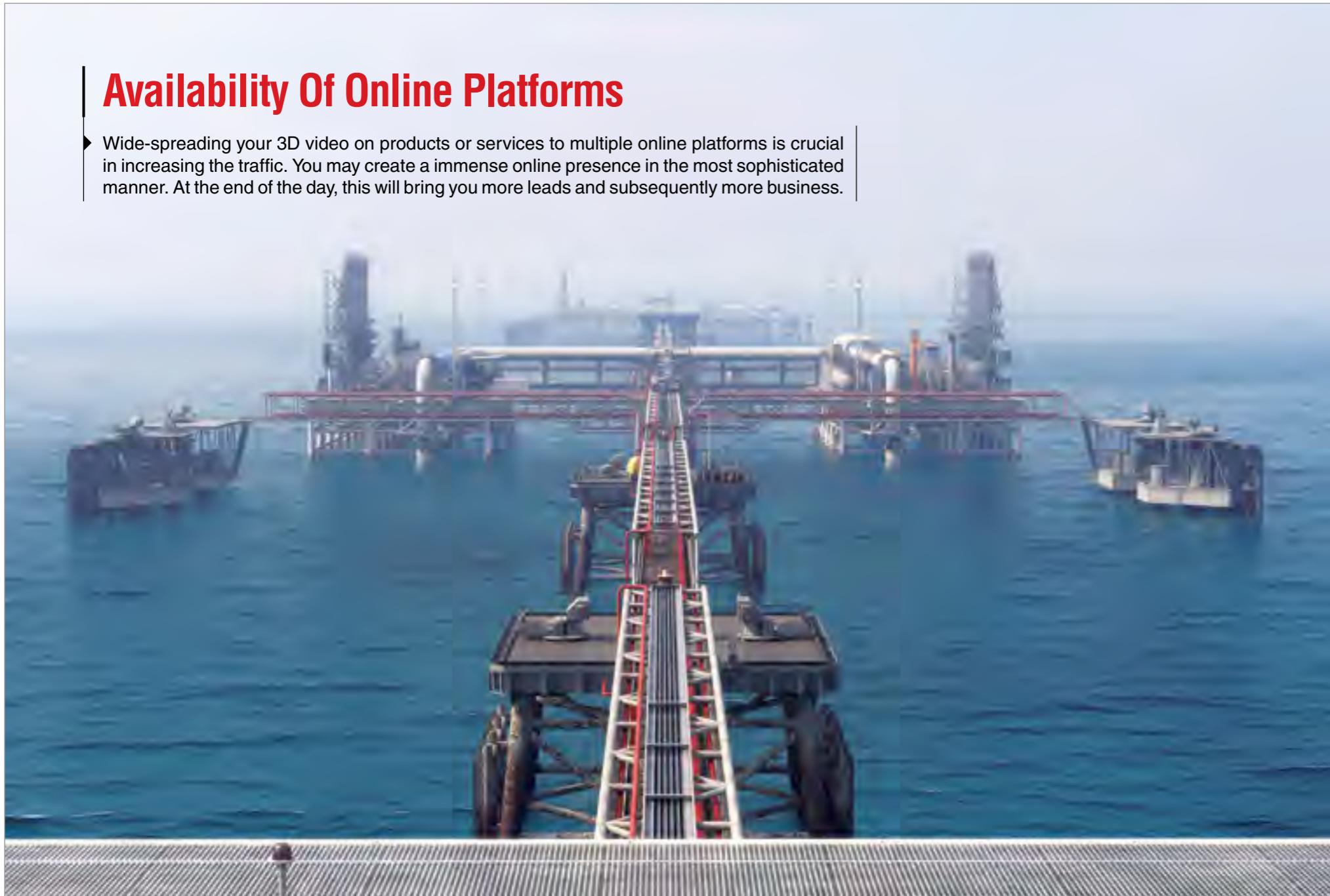





Deliver The Right Message

► After several years of delivering complex productions, we know that when you are presenting your product or your project, the message is a key. We know the principles and background behind your message. That is why we can develop brilliant visual presentations that speak to the oil and gas industry in its own language, as well as, translate complicated concepts and data into easy-to-grasp messages for those unfamiliar with the basics.

We Protect Your Data

When you work with International Energy Club, you can be sure that all the data and information that you send to us will be safe and not fall into the wrong hands or distributed online. For all our 3D animation projects, we will sign a non-disclosure agreement (NDA) and our entire staff will abide by that agreement. This gives your company assurance that your data and information are secure.





Your Privacy Will Always Be Respected

► How to choose the best Animation Studio — In all cases, our computer systems are continually backed up by secure servers behind some of the best firewalls in the industry and we routinely sign non-disclosure agreements so that your project can remain completely confidential for as long as you like. You can rest assured, you'll never lose a file with us and your privacy will always be respected.







Our Clients Can Trust Us To Deliver The Project Within The Agreed Budget

▶ We will review all the data information before starting the project and give our client a fixed budget. We will keep the project within that budget. When you work with International Energy Club you know that you will get the highest quality 3D animation for the best possible price.



Strong stories, creative ideas and engaging messages are at the core of our business; we use them to build you effective video marketing campaigns.



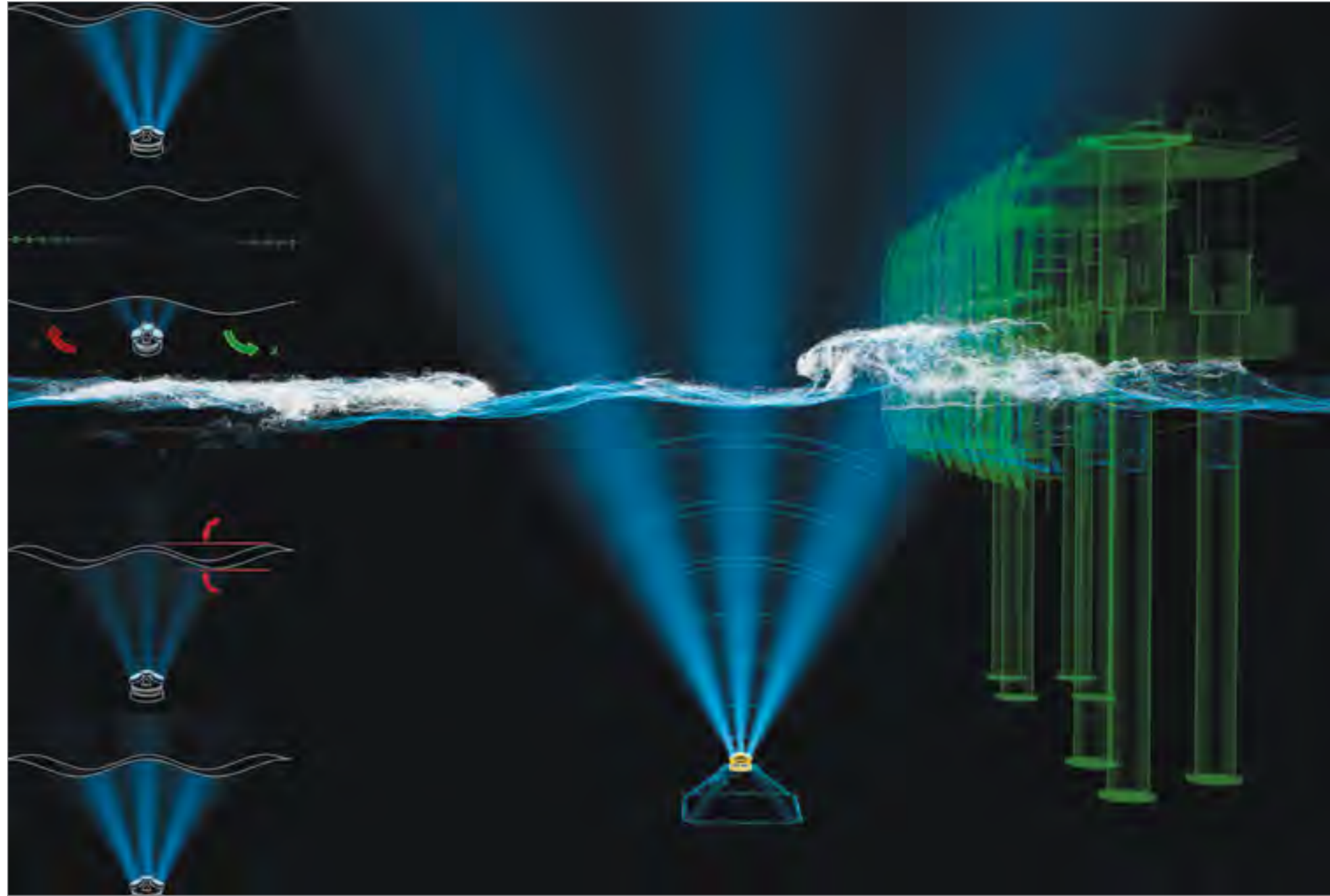



Our Clients Work With Us Again!

▶ 99% of our customers come back to work with us again. Why? Because we continue to pride ourselves on delivering the same great service and attention to details that we have from the very beginning. At the same time our ethos of trust and openness makes us great to work with. We won't baffle you with jargon, we won't let you down on a deadline and our pricing is open and fair.

Get Those Ideas From CAD To Reality

If you are in the oil and gas or energy sector and need a design built for a presentation, brochure, or manual, looking for an animation to show how your design or product will work, we can provide it. With over 10 years in the industry, we can take your product from a CAD to reality.

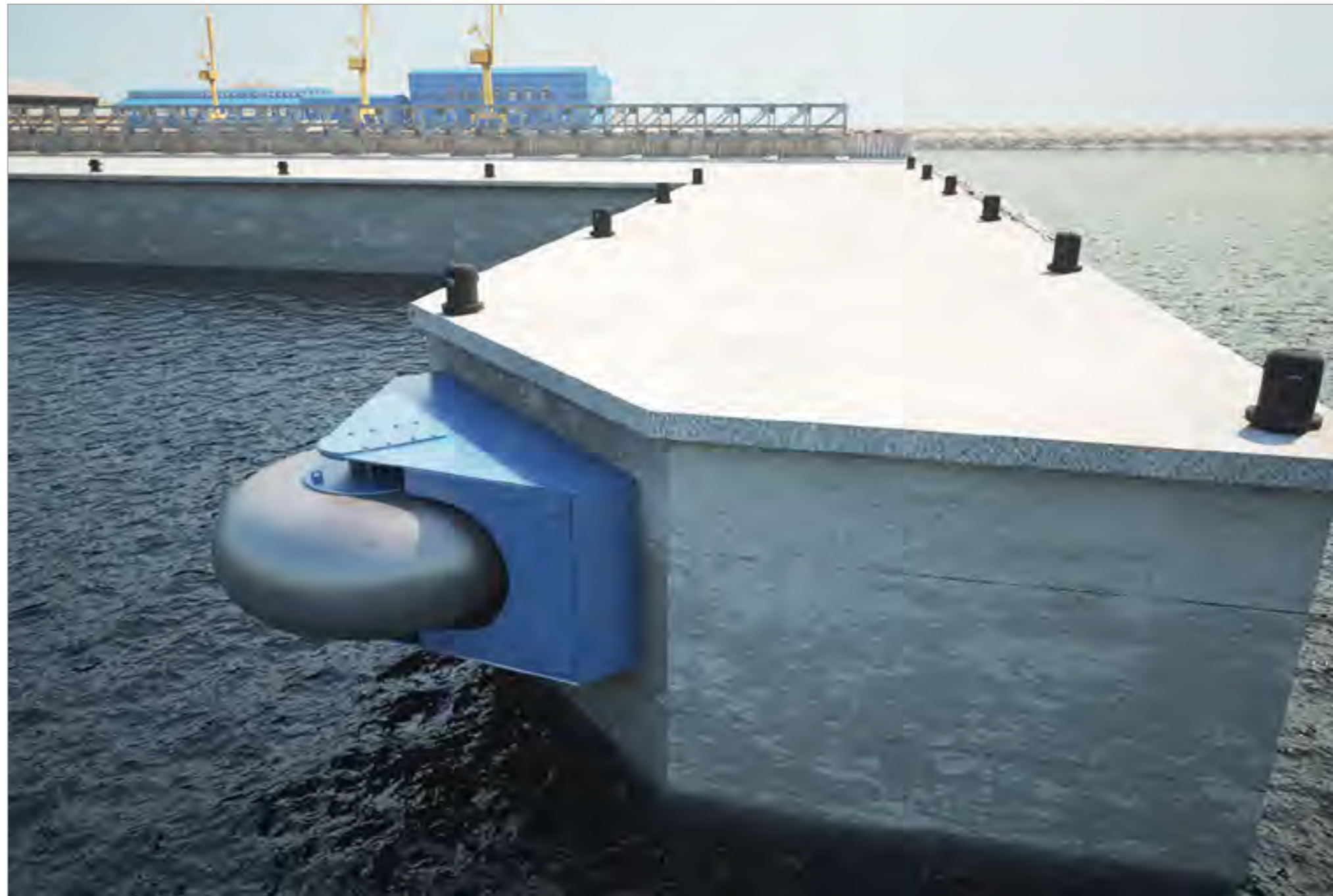





At International Energy Club, we listen to your ideas and assist you in telling a story that engages your audience. With us, you are empowered with a story that reaches far beyond your expectations as you connect online with your customers. Watch your business grow!







Cheaper Than Live Action Videos

This makes the best return on investment. No need for outdoor shootings, costly shooting setups, and actor wages brings the budget down drastically. It is certainly cheaper than many other marketing materials we use on a daily basis. The amount of profit you can gain for your business is huge compared to the money you spent in the animations for your business.

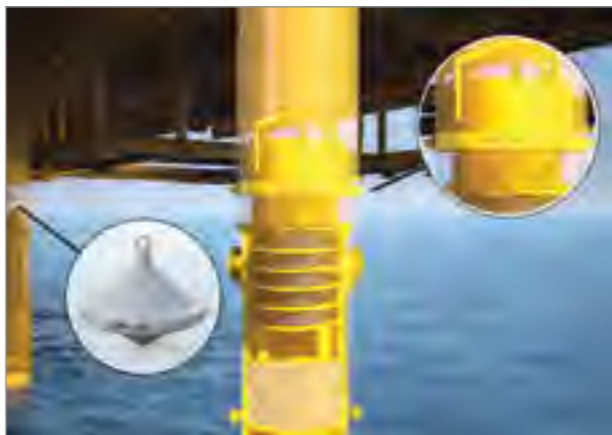

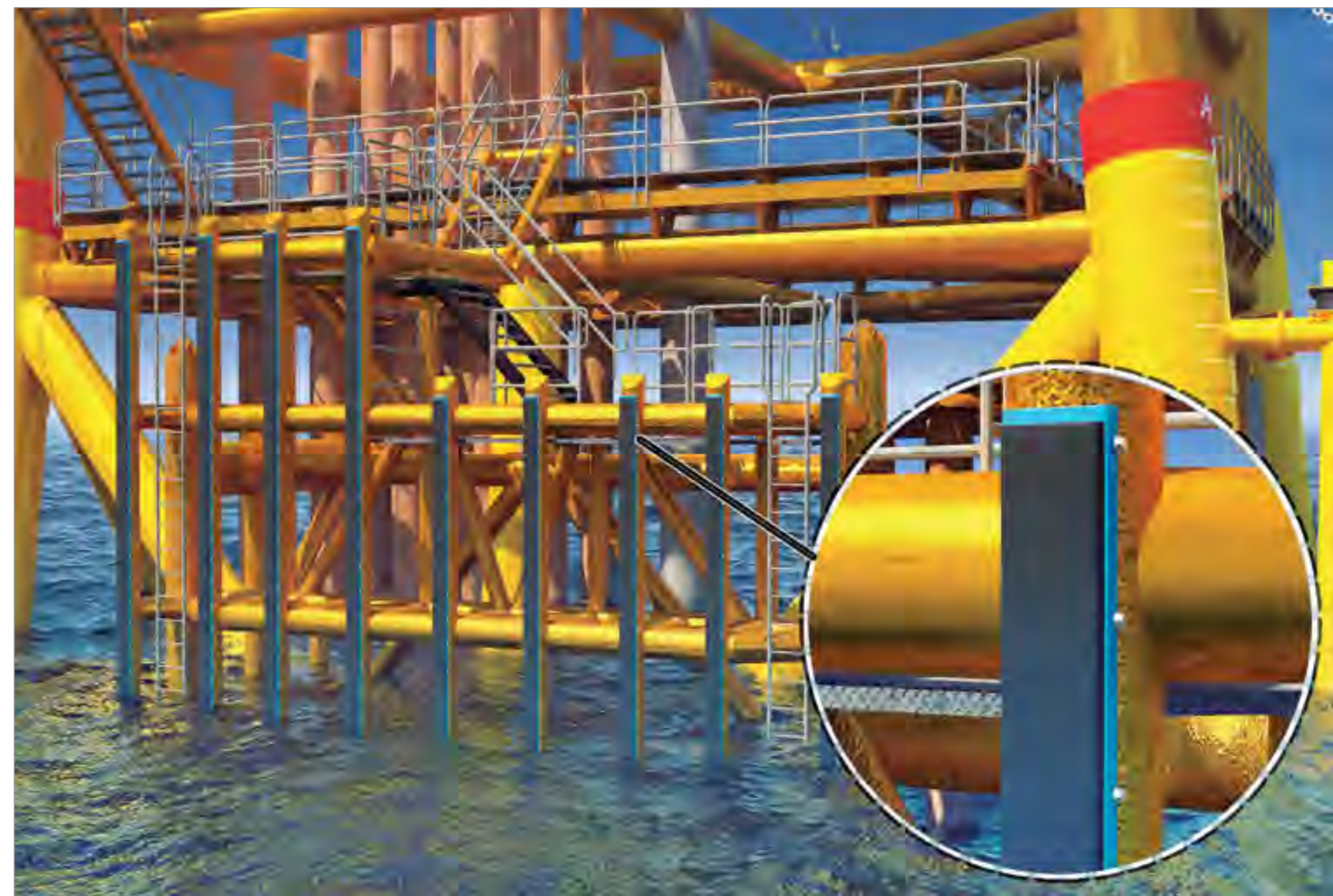
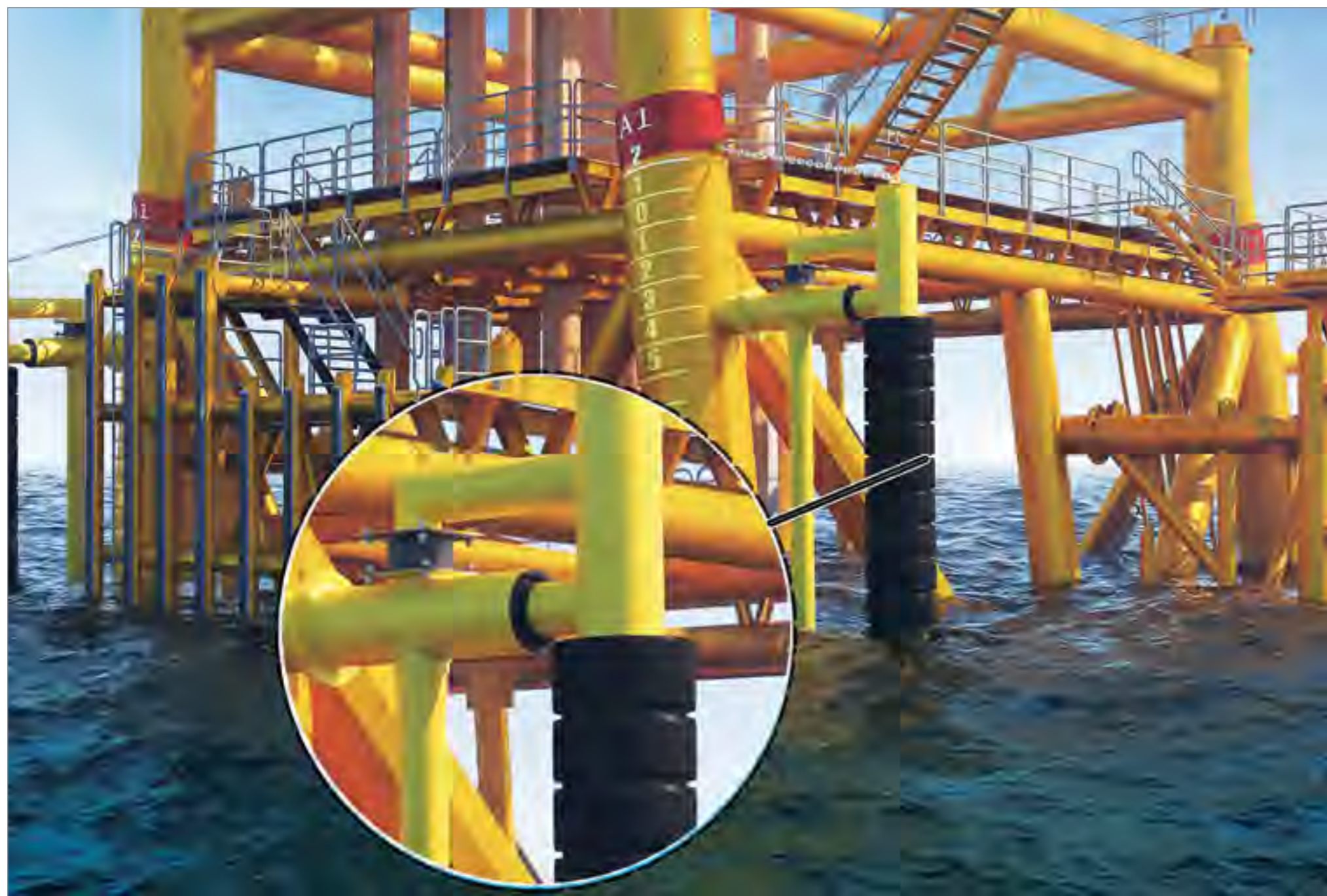



Integrity & Honesty

We believe in under promising and over delivering. Sticking to our commitments is a way of life at International Energy Club. At the same time, all our processes and systems are driven to providing services of consistently high quality. Customer delight is not just a term in the dictionary but a very real, day to day phenomenon at International Energy Club.





Do You Need World-Class Animations?

► In the highly specialized and visually complex offshore, marine, and subsea industries, the use of 3D animations has become essential for effectively communicating intricate processes, technologies, and products. These animations not only enhance understanding and engagement but also serve as powerful tools for marketing, training, and project visualization. By transforming complex technical data into visually compelling and easily digestible content, companies can ensure that their innovations are accurately represented and accessible to a broader audience. As the industry-leading 3D animation studio, International Energy Club stands unmatched in its expertise and experience, having collaborated with over 100 companies across 24 countries. With more than 800 minutes of high-quality animations produced, we are the go-to partner for companies seeking world-class animations that capture the essence of their projects and products.

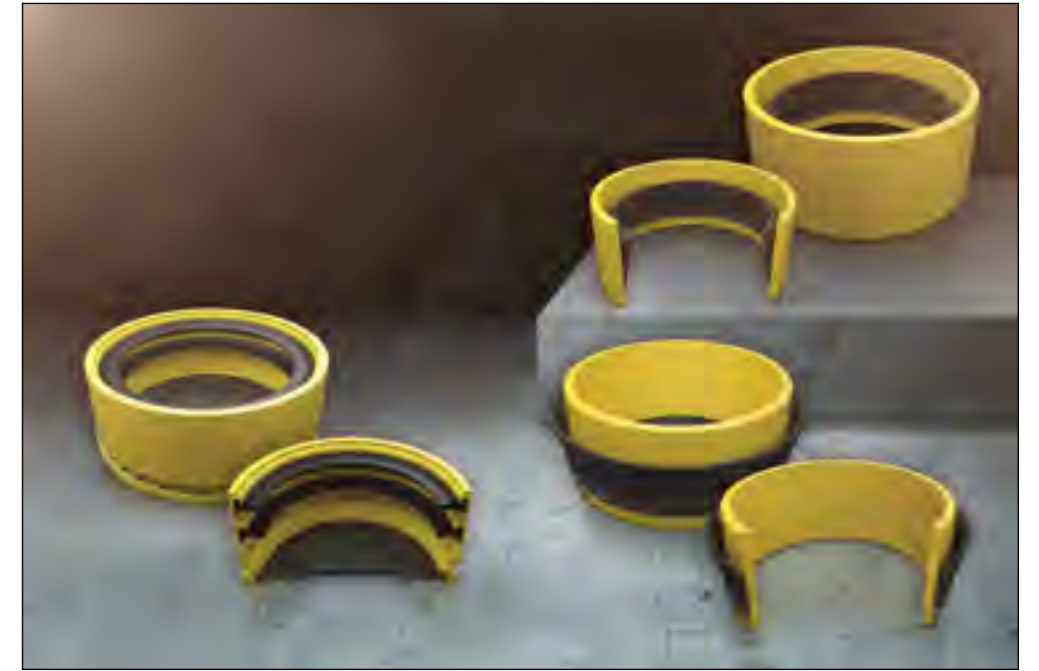



The Only Limit Is Your Imagination

▶ With our animated technical presentations, you can make a real impact at exhibitions or get right to the heart of the matter with our instructional presentations. Our animations quickly engage your potential client. Once watching, we show them why you are the one to choose.











How Do You Get Everyone Know About Your Company?

You may be working hard for your business but your business is more than just a building. Its peo-ple, products and services, it's how you interact with customers. It's how your company is per-ceived in the global market.





We Want To Make Our Success, Your Success

► We know that each of your communications projects has its own set of challenges and opportunities that merit a distinctive visual solution. So every one of our communication solutions are tailor-made presentations. We create individually customized visual communications that stand out from the crowd of the predictable and mundane.









Our Ability Is Unmatched

► We confidently proclaim that our ability to guide you to your most effective visual communications is unmatched. Customers throughout the industry rely on our insights, talent, and industry-specific knowledge. They trust us to translate their communication needs into strategic objectives and visual solutions - that are accurate, effective, easy to understand, and of the highest quality.



People Before Profit:

always delighted with our services, business will automatically happen and everything we do within the company is directed at achieving this customer delight.







Win-Win Philosophy

Our goal is to ensure that we always build win-win relationships. That way our customers treat us as their long term partners and we make sure that our customers win before we win.









We Will Deliver On Time

From our experience, we know that deadlines are very important. Sometimes missing a deadline means that the 3D animation presentation is not needed anymore! Having a trade show on Monday and receiving your final presentation one week later does not work. When you work with the International Energy Club, you can be sure that we will deliver your animation on time.







**Have A Question
Or Need A
Custom Quote?**

We help small business as well as very big international companies in the industries such as offshore oil & gas, marine and renewables energies. Contact us to help you with your next project.





We Love What We Do

▶ We are happy to tell you that today, International Energy Club is a well-known group, and a powerful pioneer in the field of high quality 3D rendering and animation services. It didn't take us long to gain a recognition for our works. Our dedication and diligence in delivering high quality results, earned us high reputation in the offshore and marine industry and we keep to do the same.







We Have Engineering Background

Whether you are in exploration phases or feasibility studies through to execution, we can bring your project to communication clarity with clear, pertinent and technically correct graphics and multimedia animations. Our engineering background allows us to take raw technical data and generate communication aids that the financial community, community leaders and pretty much anyone who doesn't have an engineering background, can quickly understand.

If You Can Dream It, We Can Give It Life

Your oil and gas industry animation must be informative, aesthetically pleasing and accurately reflective of your company brand. International Energy Club has the team and tools to make that happen for you. Tell us your vision for your oil, gas, petrochemical animation, and we will make that dream a reality. In fact, if you can dream it, we can give it life. we create your imagination.

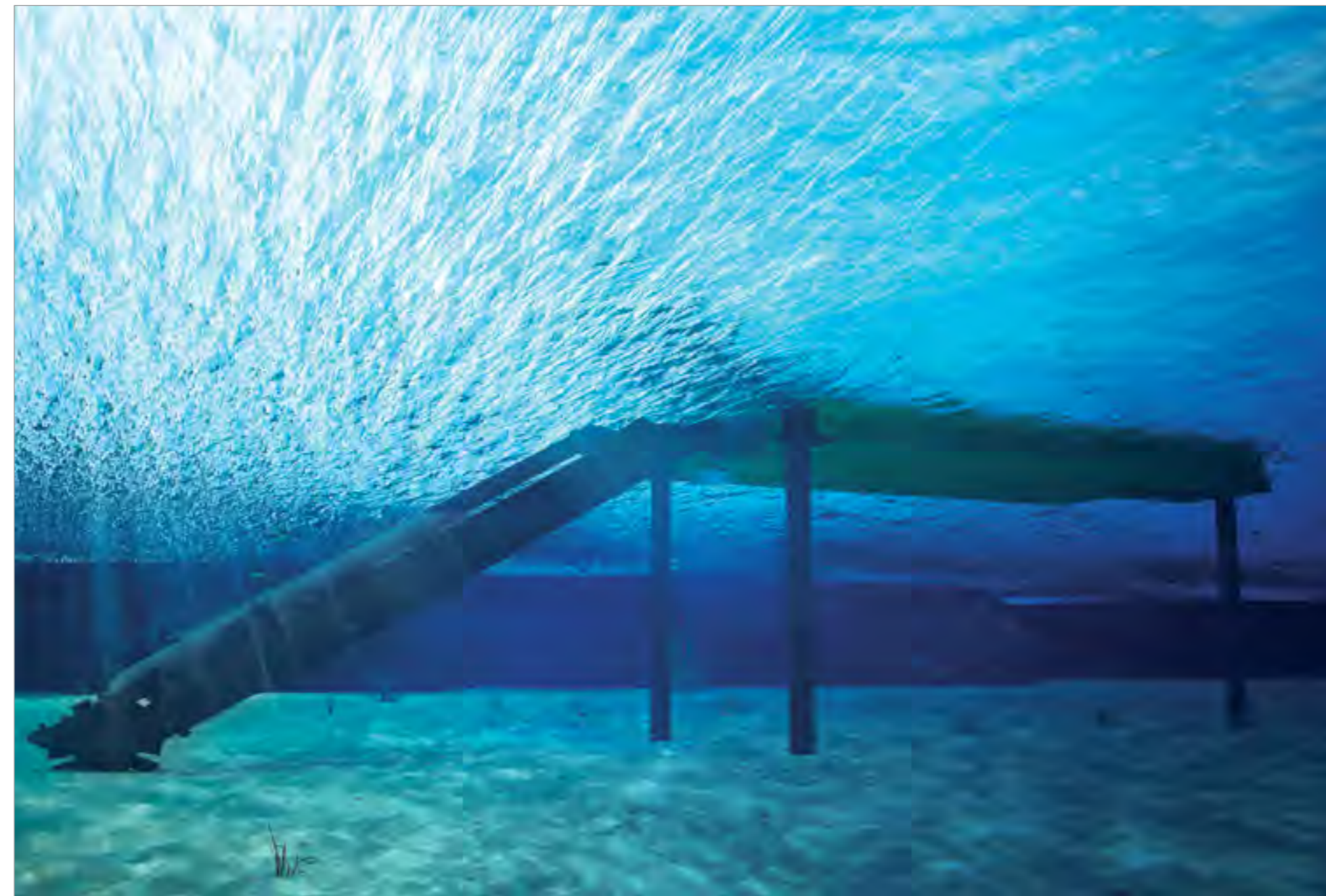

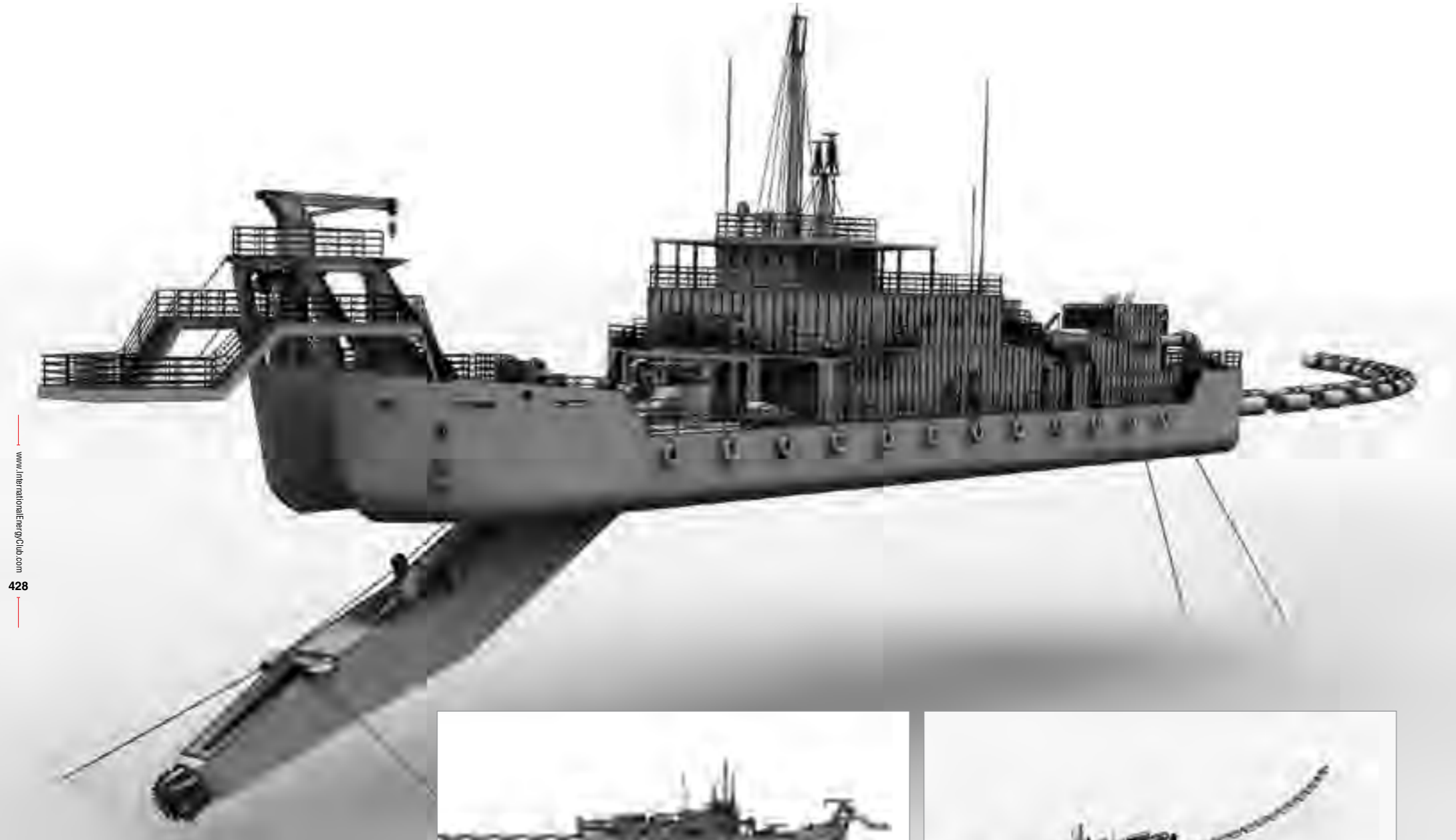





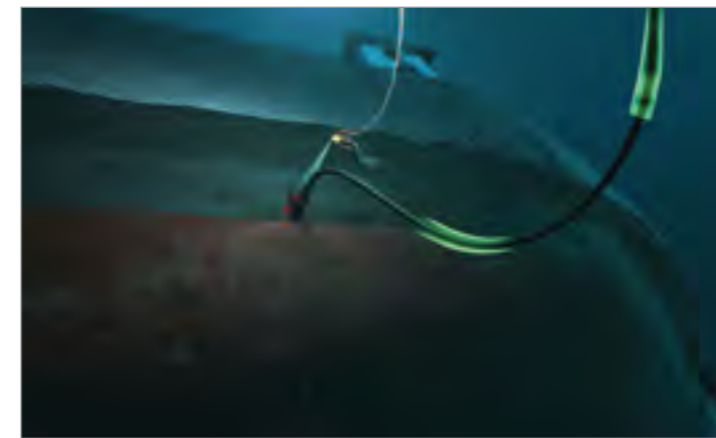
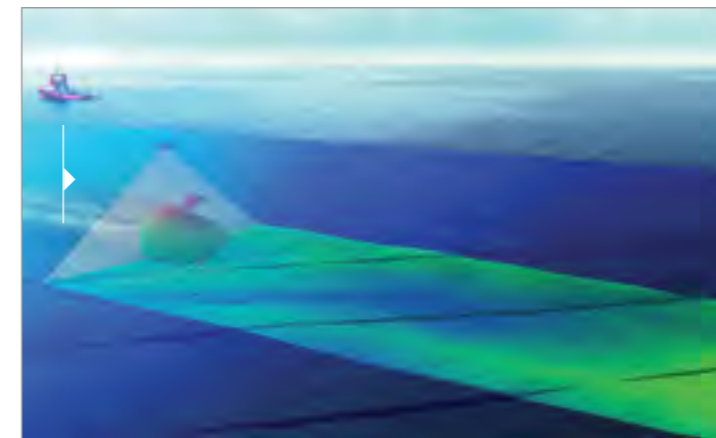

We Put You On An Even Playing Field With The Big Companies

You don't need the same big pockets as the big guys. The truth is that our skilled artists, programmers, and developers—as well as advanced computing—have the ability to put on every bit as good a show as your biggest competitor. We work with the small companies and we work with the big companies—we know how to make a trade show presentation and just because you may be a little fish in a big pond doesn't mean we're going to do anything less than our best for you. The same action-packed animation expertise that we deliver to the Fortune 500s we will deliver to your local company.

We Consider Our Clients As Partners

► At International Energy Club, we consider our clients as partners, in a joined effort to establish, sustain our business relationships, and foremost... solve their challenges using our proven, creative process, and proprietary systems. Our reward comes from seeing the results obtained from aligning our clients' vision with their success.

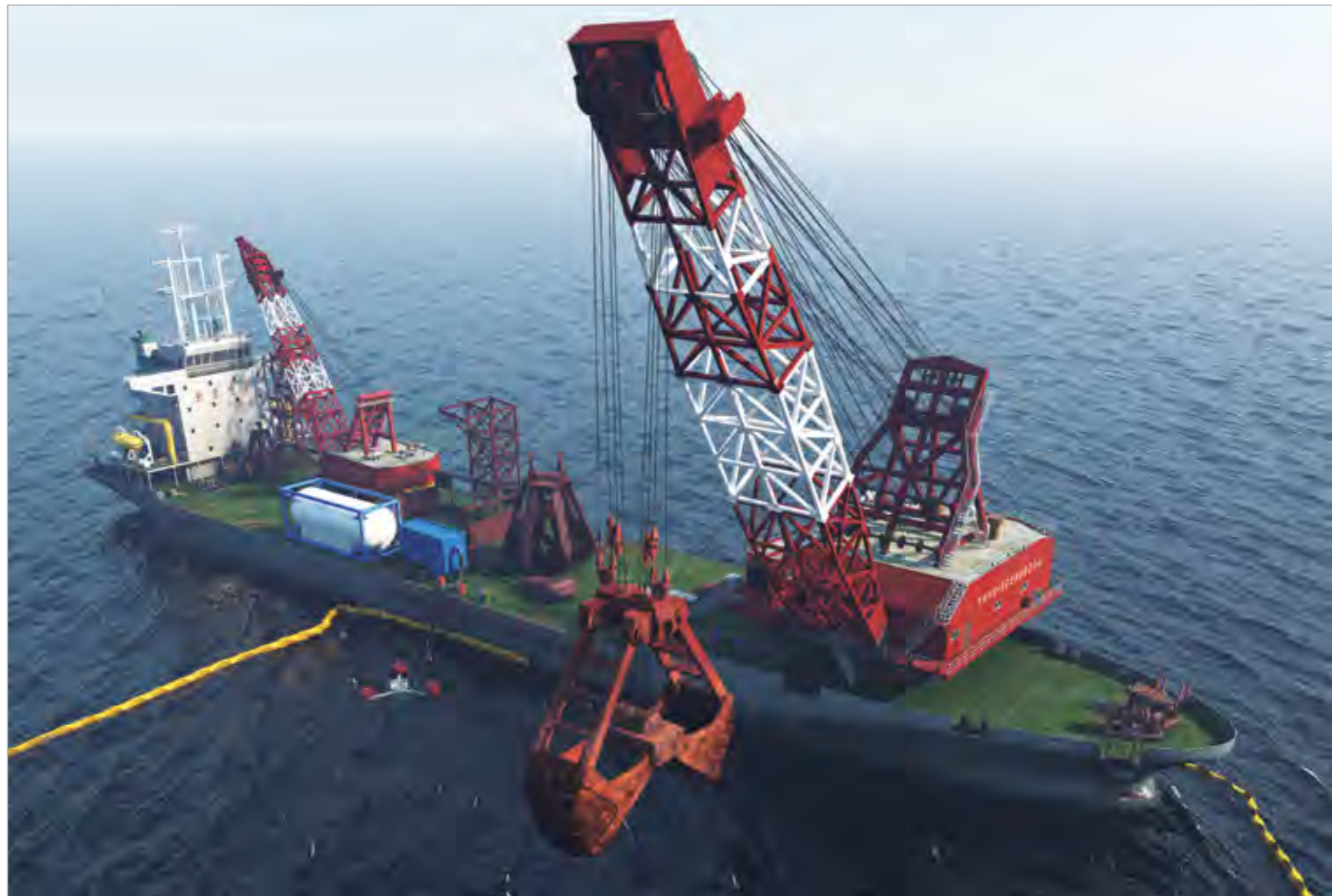





Know Exactly What To Expect And When To Expect It

▶ Making a custom 3D or 2D animation or video is a process with multiple steps. You may be wondering how can you be involved in the creation of your custom animation video project when you may not have all the knowledge about how animation is even created or the steps involved? Not to worry! We are experts in creating custom animation and graphics and have been doing it for over 13 years. We will guide you every step of the way to ensure you're never lost and that you're fully informed with all of your options.





We Create Your Imagination

Your animation must be informative, aesthetically pleasing and accurately reflective of your company brand. International Energy Club has the team and tools to make that happen for you. Tell us your vision for your oil, gas, marine or renewables animation, and we will make that dream a reality. In fact we create your imagination.





We Give Our Very Best To Every Project

► We help you to express your company vision and your products with unforgettable impact & clarity. We don't let you lose even a single moment, to shine in front of your clients and your competitors. The beauty of our communication solutions lies in precision, perfection, and simplicity. We offer extraordinary services, like no other you'll find.





You have a million-dollar idea in your mind, and now the trick is making someone see that. That's why we create 3D animations & 3D simulations. You get to present your idea to the world. Not in an "okay" format, but in a perfect, cost-effective way. From product simulations and creative storytelling to dangerous training scenarios, or technical animations, interactive 3D services are the key to fulfilling all of these needs. You may ask how 3D animations work so effectively. You can engage your audience with both visual and audible stimulation to explain your products and services. In addition, interactive 3D animations give your audience something to feel. Animations show viewers what is challenging to see, explain or feel. Therefore, it gives you the ability to effectively market & sell your products, services and offer better training & teaching solutions



We Work Late & Weekends Just To Make Sure Your Project Exceeds Your Expectations

► We are always available and accessible to service your needs or report you at least twice a week during production. We don't pass you off to junior staff members like so many animation or video production companies do. we take responsibility and accountability for ensuring you get the most value for your marketing investment. We're serious when we should be because great marketing can make the difference between life and death for some companies. Hence, you can message or call us 24/7 and you'll always be able to get a hold of us the same day but with the convenience of being awake and working when you're awake and working. We work late and weekends just to make sure your project exceeds your expectations every time on time.







We Want You To Be Wowed

we believe the key difference comes down to our true commitment to you, the client. We want you to be wowed. We want your presentation to knock people over in their chairs. Bottom line? We want our work to affect your bottom line. And we'll do whatever it takes to get it done.



We Are Only Happy When We Exceed Expectations

▶ When offshore and marine company's executives seek the very best solution to their most important communication tasks, they routinely turn to us. We too, are industry experts. We offer them the leadership and guidance they need to trust with confidence that their visual communications will get noticed, and get the job done to the highest standards. Tight deadlines, challenging conditions and complex messages are all things we tackle on a daily basis. Our team approaches every project with energy and passion and we are only happy when we exceed expectations.

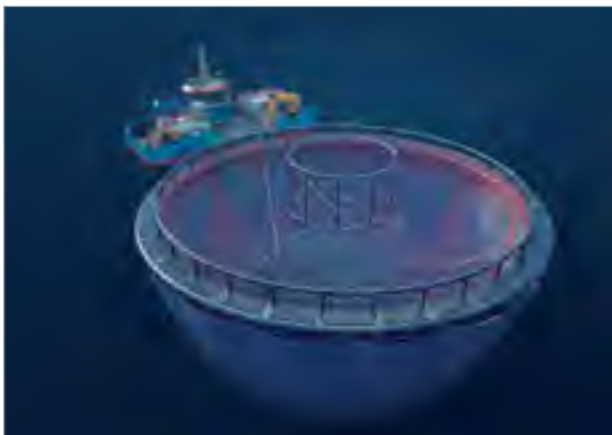

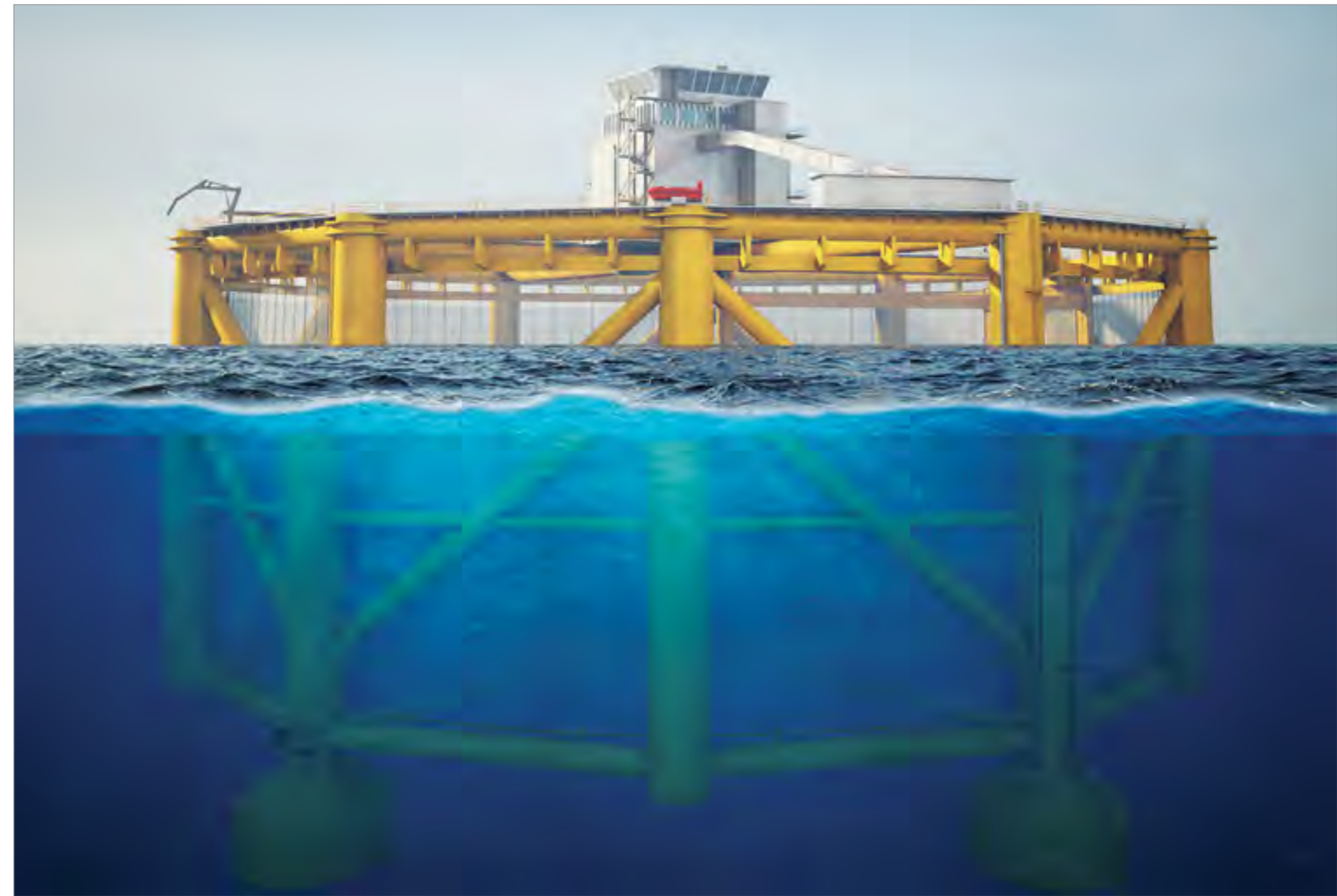

No Other Medium Can Match The Strength Of 3D!

The power of 3D animation does not only limit it to attract the viewers for the particular product or service but also portrays the overall standard and vision of your business. Without a doubt, no other visual or audio medium can match the strength of 3D animations when it comes to delivering a stunning and concise portrait of a product. It not only portrays the visual beauty but also engages audiences with super realistic effects.

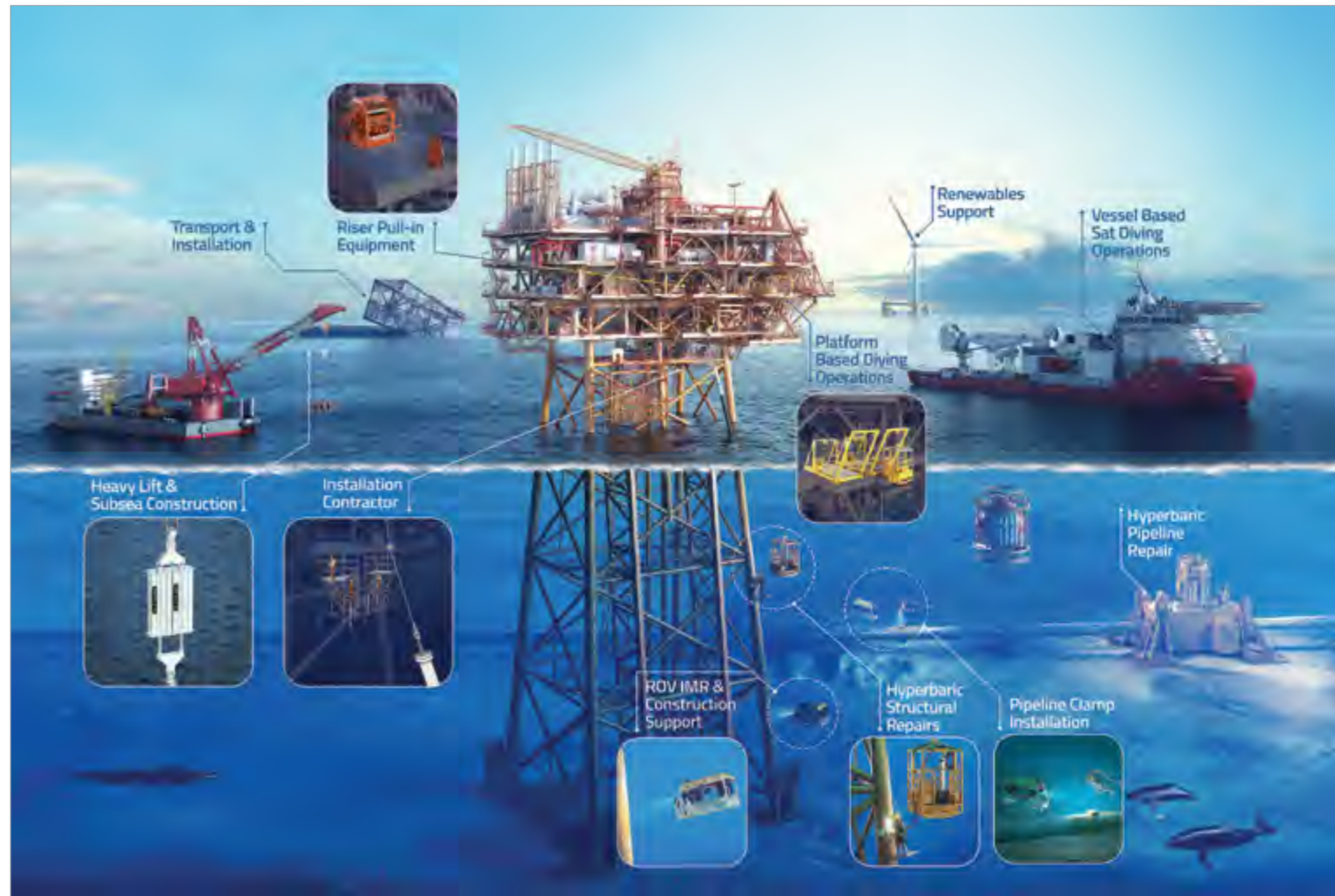



We Know What You Do

▶ From demonstrating new technologies to realistically portraying specific processes, 3D animation is a powerful tool in the oil and gas world. We have a long history of developing 3D content for service companies and operators in the private sector, and have built one of the largest libraries of oil and gas models in the Oil industry. Our animators and producers understand oil and gas processes and have assembled a large portfolio that demonstrates our expertise.



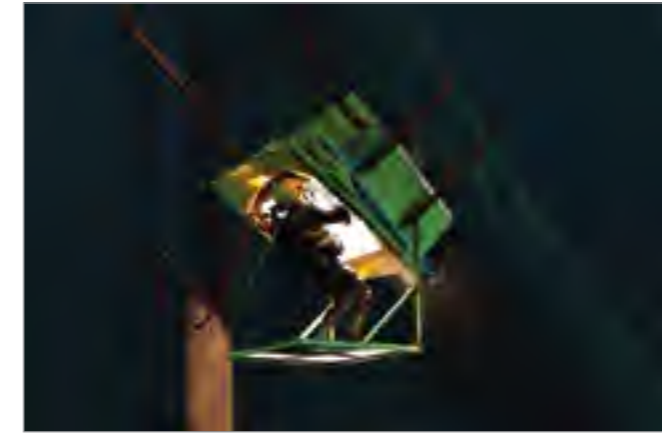
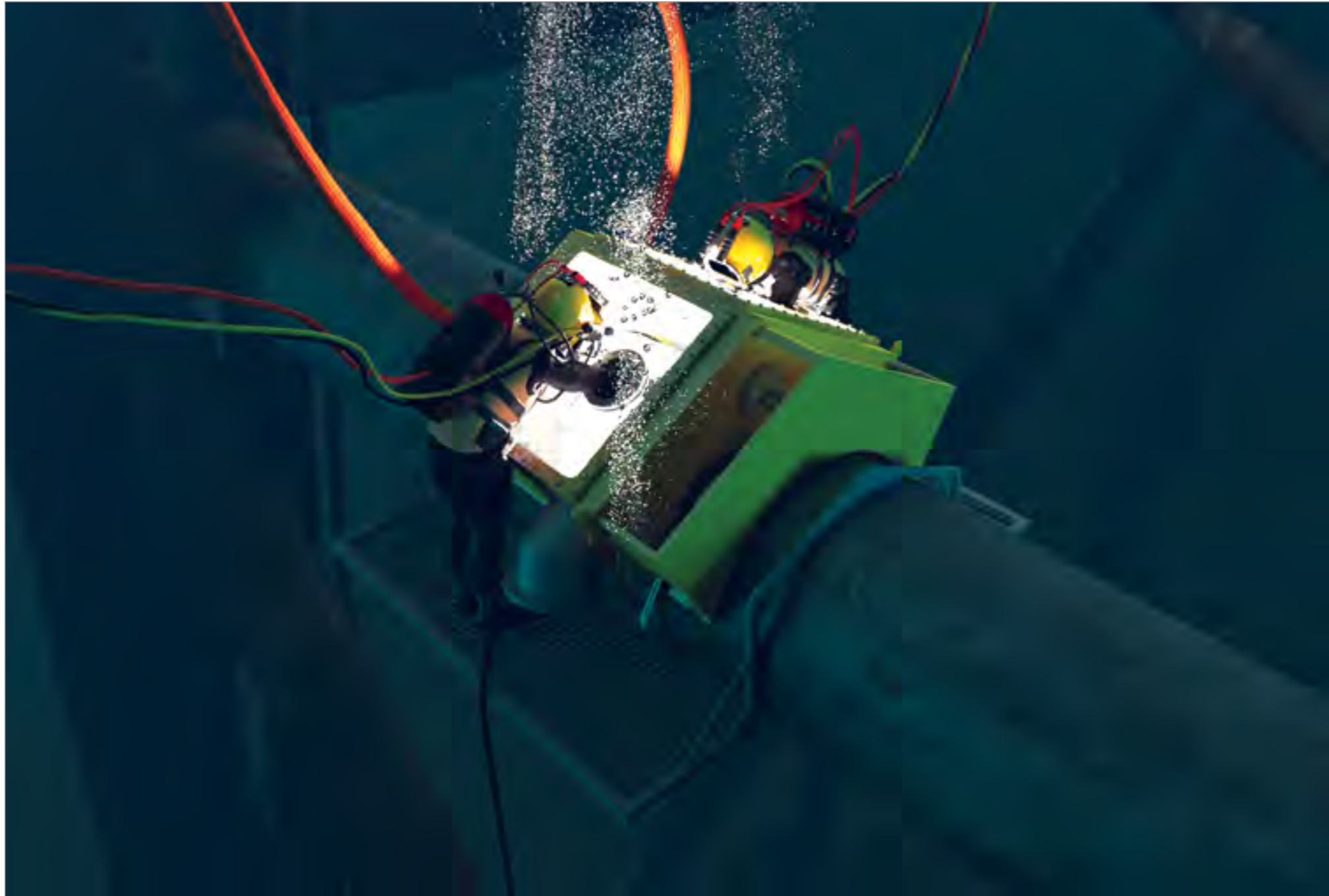

Animation Brings Your Ideas To Reality

There has never been a more remarkable answer to your needs than utilizing 3D animation to market your product, explain your idea, or safely train employees. 3D animation brings your ideas to reality.

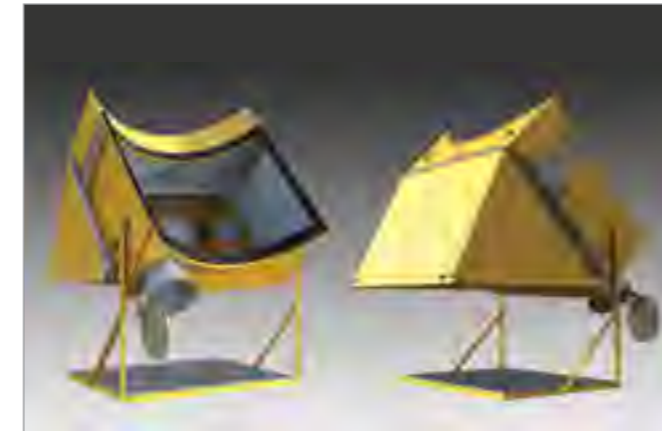





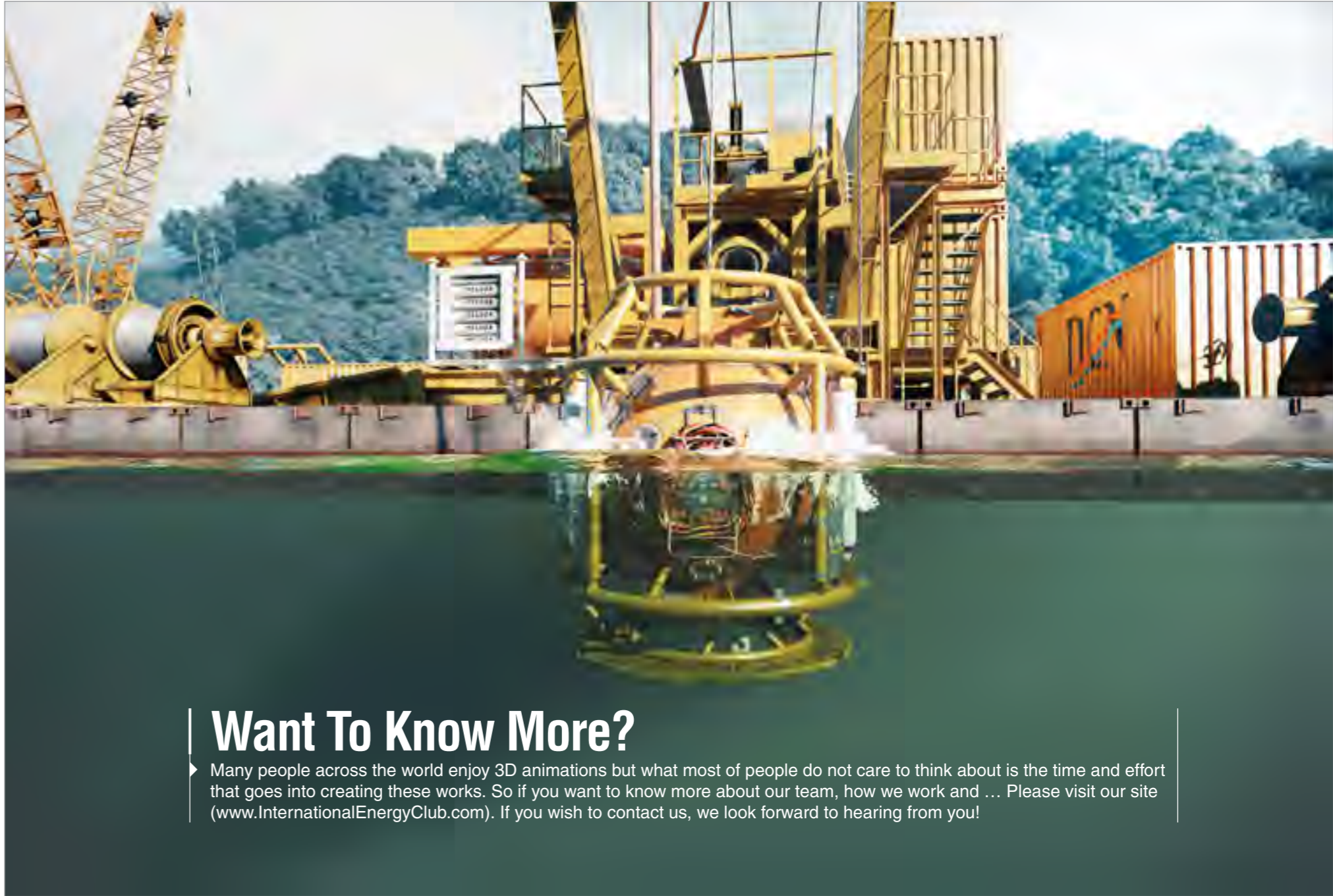
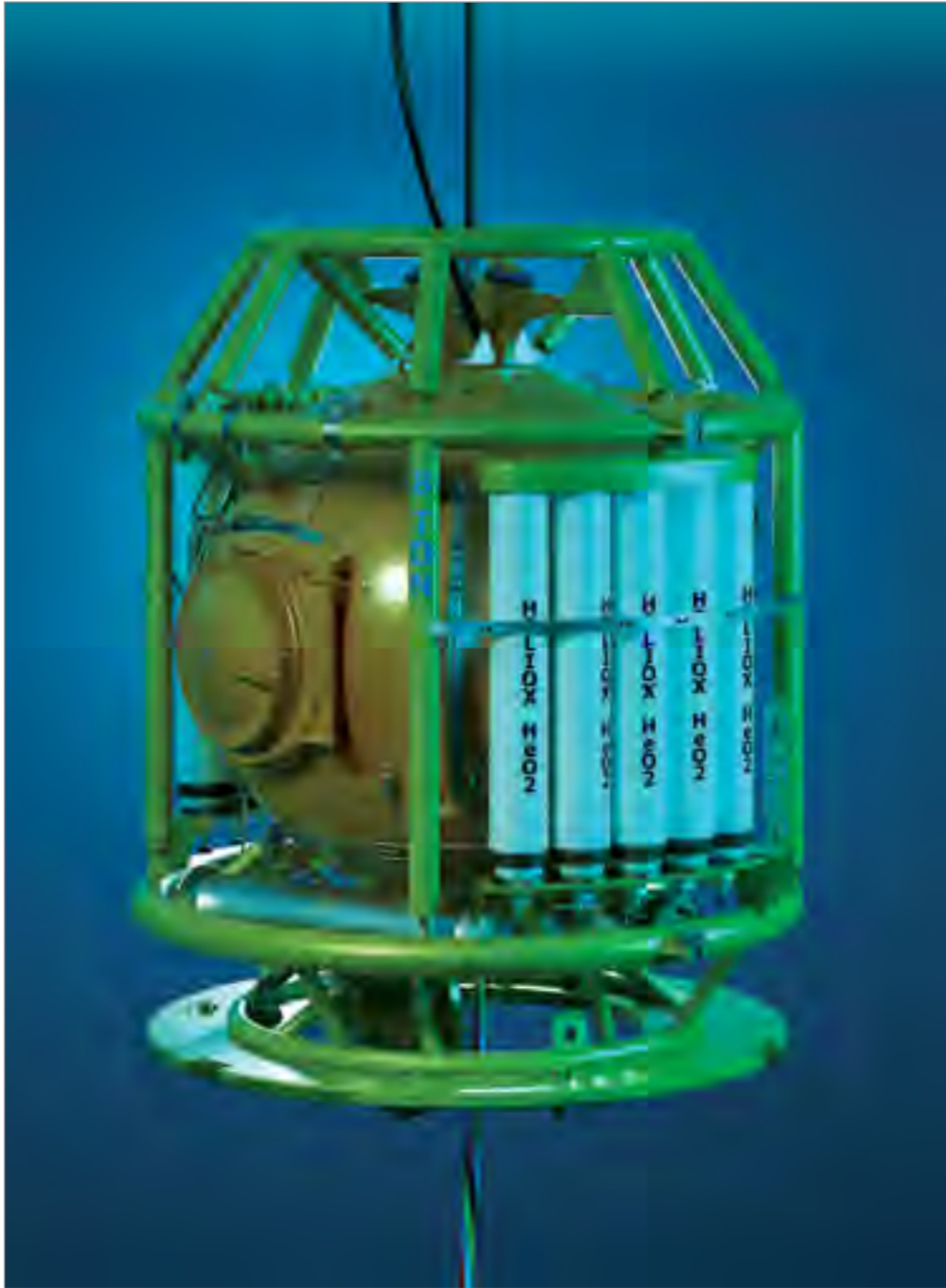

Want To Know More?

Many people across the world enjoy 3D animations but what most of people do not care to think about is the time and effort that goes into creating these works. So if you want to know more about our team, how we work and ... Please visit our site (www.InternationalEnergyClub.com). If you wish to contact us, we look forward to hearing from you!





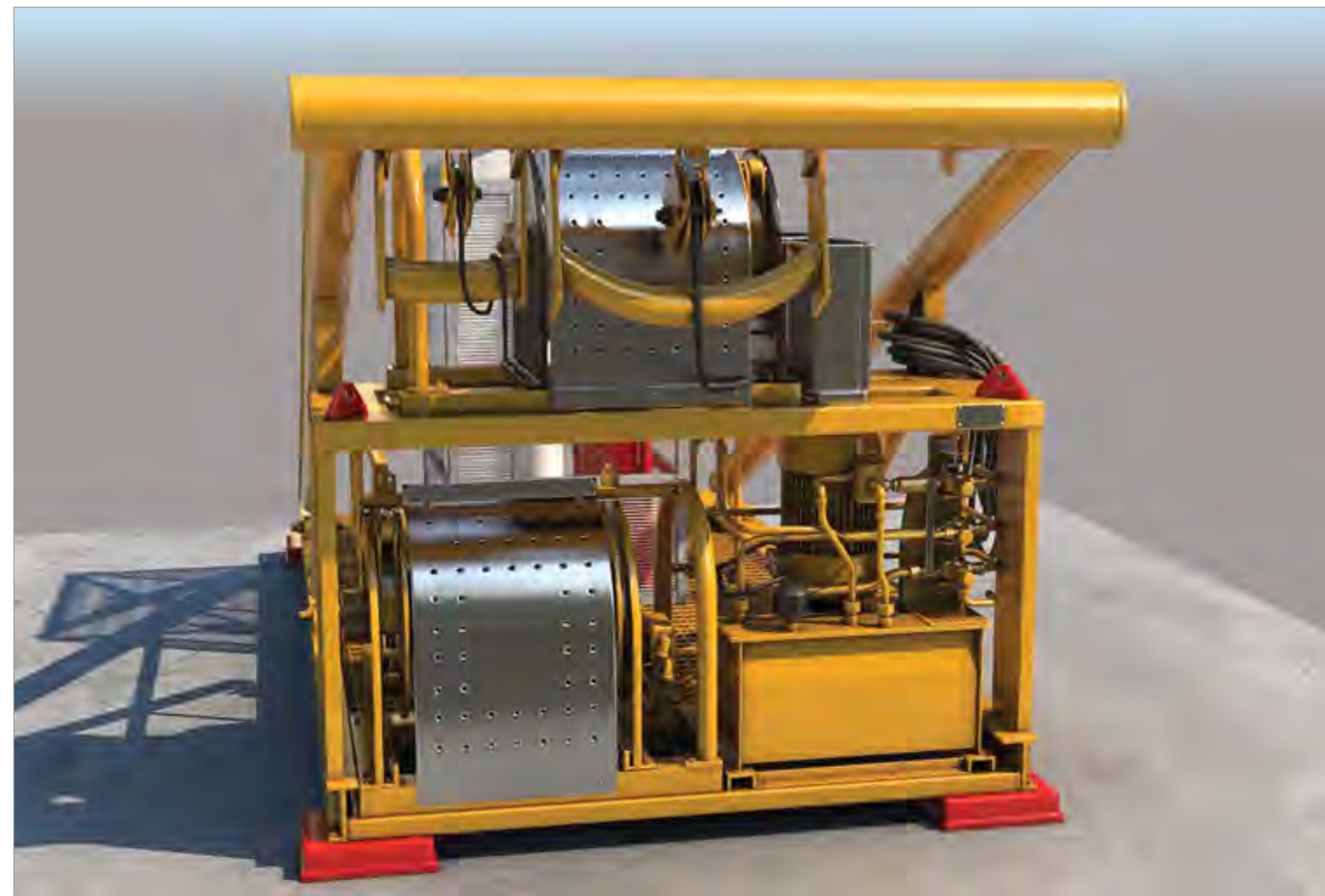



We Can Draw Attention To You

We've all walked the trade show floor, passing booth after booth, eyeing the tables to see if they have any good swag but generally skimming the crowd for something to catch our eye. Of course there are going to be the big companies there with the huge budgets who make a splash with a fancy booth, but we've found that with the right eye-catching video, we can draw attention to you whether you are the billion-dollar behemoths and or the mom-and-pop shop across the aisle.

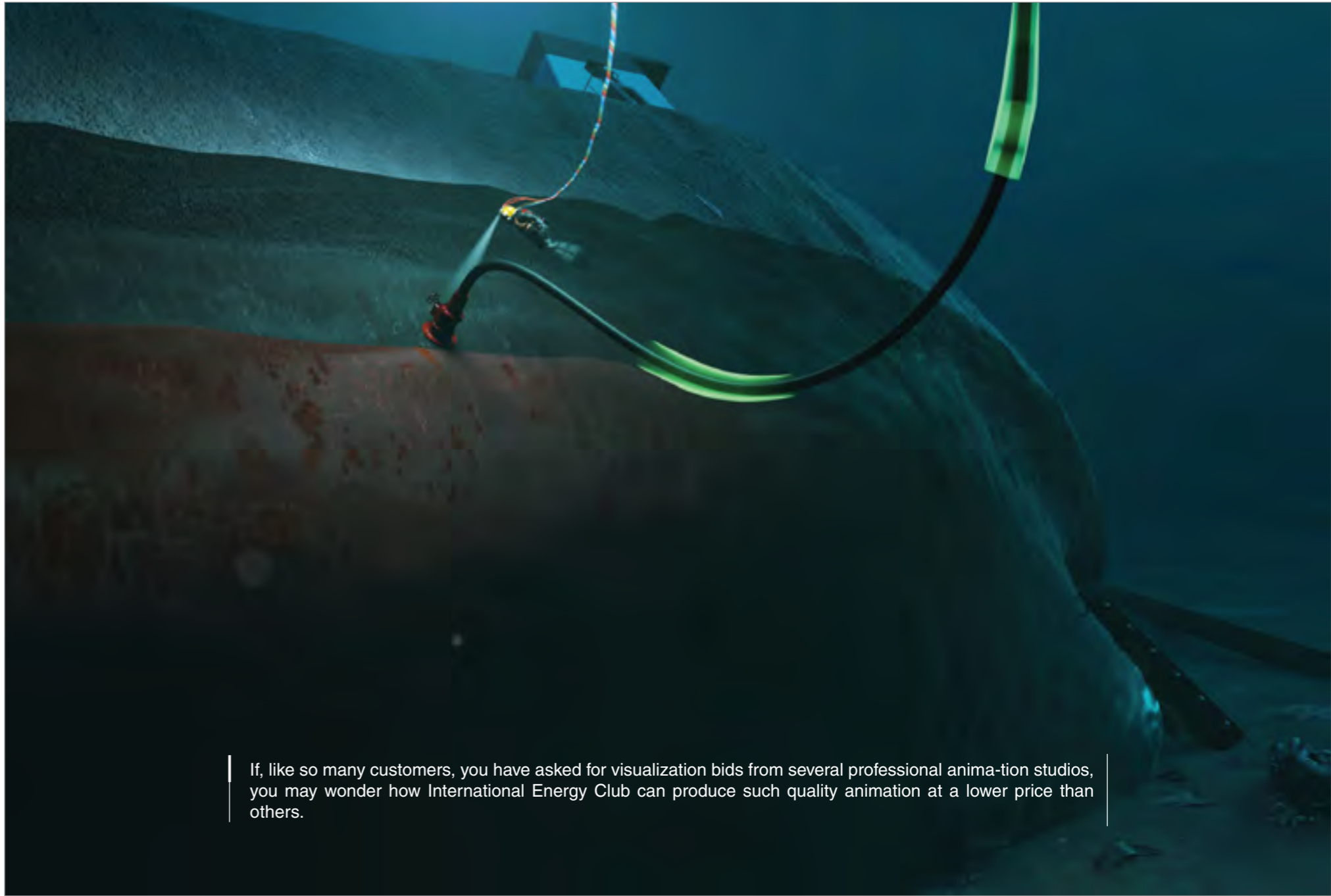

If, like so many customers, you have asked for visualization bids from several professional anima-tion studios, you may wonder how International Energy Club can produce such quality animation at a lower price than others.





Our Rates Would Make You Smile

► We do our due diligence by checking our competitors to make sure International Energy Club' pricing is at or below market rates. In our company pricing is based to duration of your project and how many days it takes for us to make it. Because more complex animation and realistic rendering takes longer and therefore costs more. At the same time, changes during production can impact price, and we'll counsel with you about that. You'll never get a surprise charge from us and will always approve a full scope of work before we start so you know where your hard-working marketing dollars are being spent.

We Help You to Share Your Ideas With The World

Do you have a great ideas, concepts or products you would like to share with the world? We communicate and present complex information.

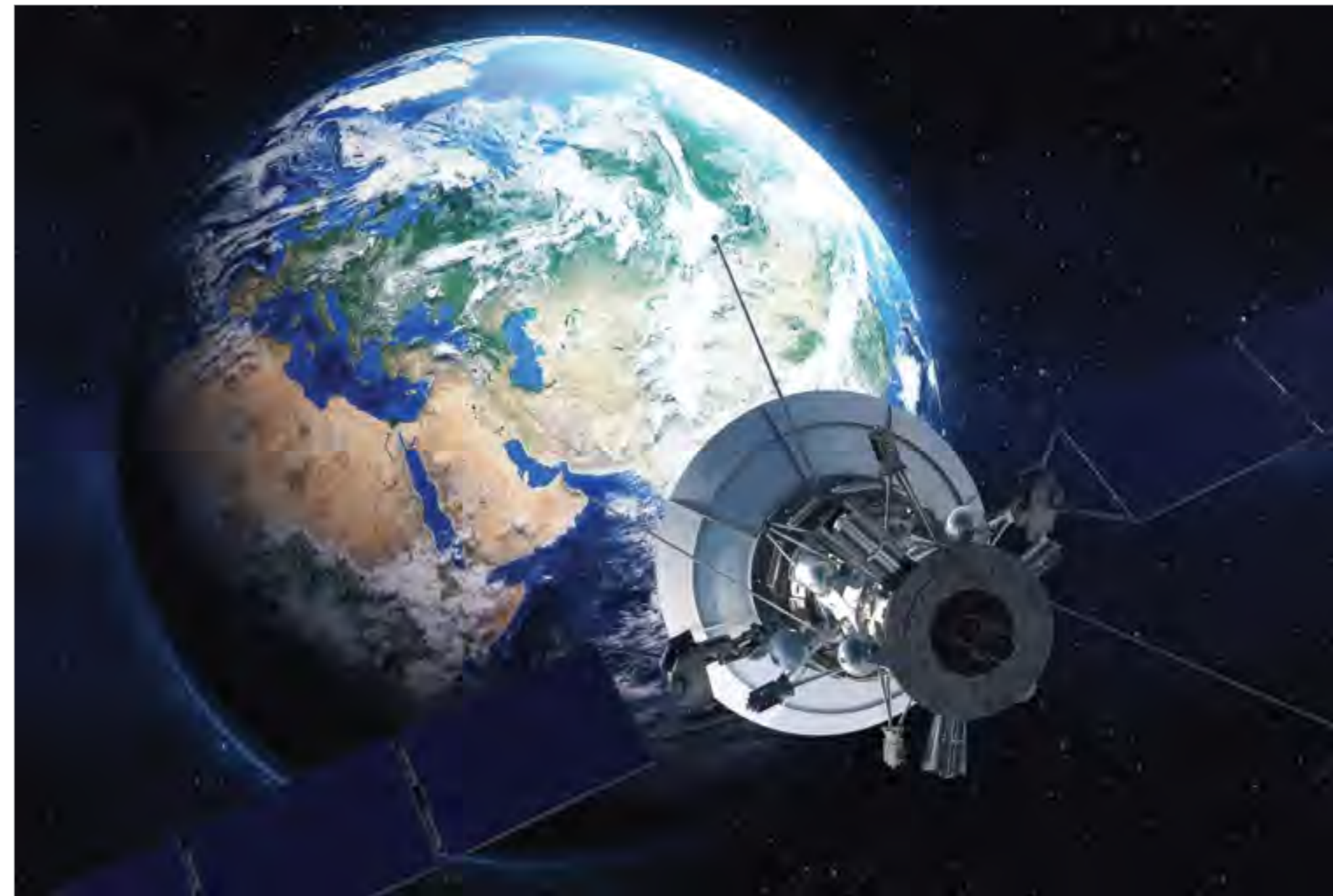



There Is A Reason Why Our Clients Have Trusted Us with Their Projects

It's never an easy climb to the top. But it's a lot faster when you're not on your own. We can be your support, your guide and your competitive edge. Our goal is to work with you to create the most value for your project and budget. We do that by continually challenging ourselves to go beyond the expected for our clients. We arrive at strategic solutions with careful thought and diligence. We design every visual element with extreme accuracy and detail and complete every project with the highest standards of professionalism. And we work hard to deliver every project on time and on budget.

Trusted By Industry Leaders



WWW.INTERNATIONALENERGYCLUB.COM

Tomorrow is Late, Contact Us Today

To get the professional animated video you need for your brand, visit International Energy Club website and see our sample videos and call us for arranging a meeting. We understand the importance of staying professional while also creating engaging content that your audience will love.

We Create Your Imagination ...



WWW.INTERNATIONALENERGYCLUB.COM |
INFO@INTERNATIONALENERGYCLUB.COM |
INTL.ENERGYCLUB@GMAIL.COM |